

# ABS Guard OnTop Falz

SG2-GUARD-PF-XX-XX



MoA 294-01



DIN EN13374:  
2013 - A



## Werkzeuge | Tools

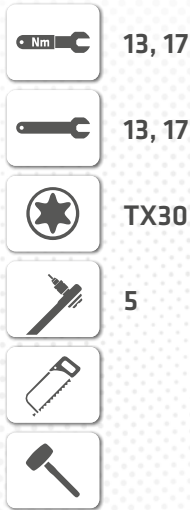

## Sicherheitshinweise | Safety instructions



- DE** Montageanleitung beachten (1) und Sicherheitshinweise beachten (2).
- EN** Comply with the installation manual (1) and Comply with the safety instructions (2).
- FR** Respecter la notice de montage (1) and Respecter les consignes de sécurité (2).
- NL** Montagehandleiding in acht nemen (1) and Veiligheidsinstructies in acht nemen (2).
- BGR** Спазвайте инструкциите за монтаж (1) and Спазвайте инструкциите за безопасност (2).
- DK** Følg monteringsvejledningen (1) and Følg sikkerhedshenvisningerne (2).
- ET** Järgige paigaldusjuhendit (1) ja ohutusjuhiseid (2).
- FI** Noudata asennusohjeita (1) and Noudata turvallisuusohjeita (2).
- IT** Rispettare le istruzioni di montaggio (1) and Rispettare le istruzioni di sicurezza (2).
- PL** Przestrzegać zaleceń instrukcji montażu (1) and Przestrzegać zasad bezpieczeństwa (2).
- SK** Dodržujte návod na montáž (1) and Dodržujte bezpečnostné pokyny (2).
- SL** Sledite navodilom za namestitve (1) and Sledite varnostnim navodilom (2).
- ES** Observar las instrucciones de montaje (1) and Observar las indicaciones de seguridad (2).
- CS** Dodržujte návod k montáži (1) and Dodržujte bezpečnostní pokyny (2).
- HU** Vegye figyelembe az összeszerelési útmutatót (1) and Vegye figyelembe a biztonsági utasításokat (2).

Für eine ordnungsgemäße Montage ist eine Dokumentation des Einbaus zwingend erforderlich!  
For a proper installation, a complete documentation of assembly is absolutely necessary.

## Kontakte | Contact persons

### Vertrieb & Technische Beratung Sales & Technical Support

+49 (0) 28 32 - 972 81 - 0  
vertrieb@absturzversicherung.de

### Schulung Training

+49 (0) 28 32 - 972 81 - 148  
schulung@absturzversicherung.de

### Montagevorbereitung Assembly

+49 (0) 28 32 - 972 81 - 260  
service@absturzversicherung.de

## Mustertypenschild | Sample label

[ABS]

**ABS SAFETY GMBH** 3

Kevelaer, Germany  
info@absturzversicherung.de  
www.absturzversicherung.de

1
2

---

**Mustertypenschild /  
Sample only**

**Chargennummer /  
Batch number**

---

6 Normen / Standards

7 Max. Nutzer gleichzeitig (DIN EN 795:2012)  
Max. No. of simultaneous users

11 Modellnummer / Model number

  -

  -

  -

-

  -

  -

  -

  -

  -

CE  
0158

Z-14.9-688

9  
  
10

**Inhalt | Content**



05

**Rundbördelfalz /**  
 Rounded-edge seam



11

**Stehfalz /**  
 Standing seams



20

**ABS Guard Toeboard**

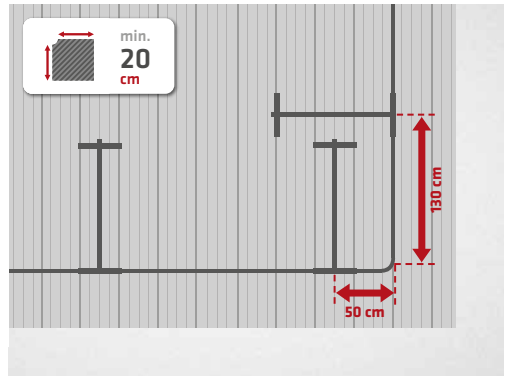
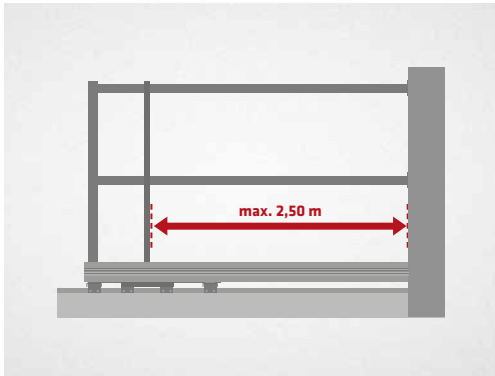

# Montageschritte dokumentieren

Document assembly step



Dokumentation mit Bildern vervollständigen!  
Complete your documentation using pictures!

**Dokumentation  
ist Pflicht!**  
Documentation is compulsory!

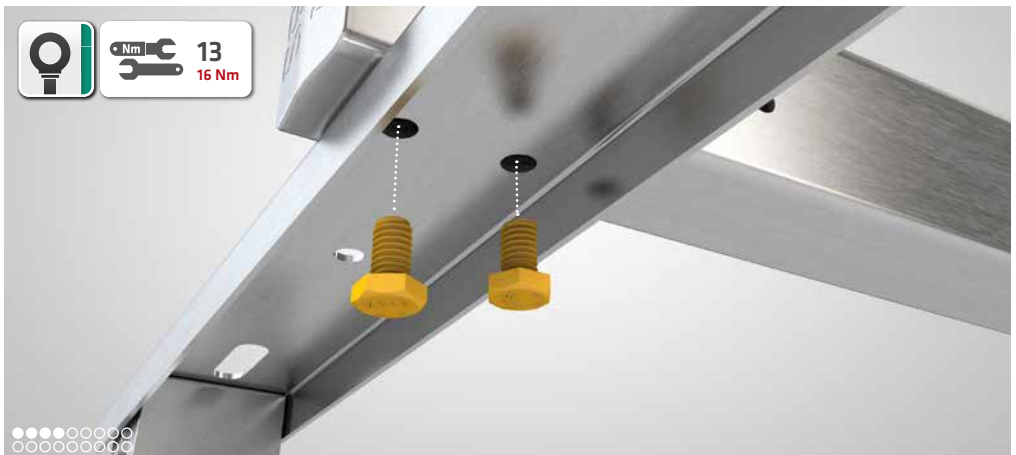
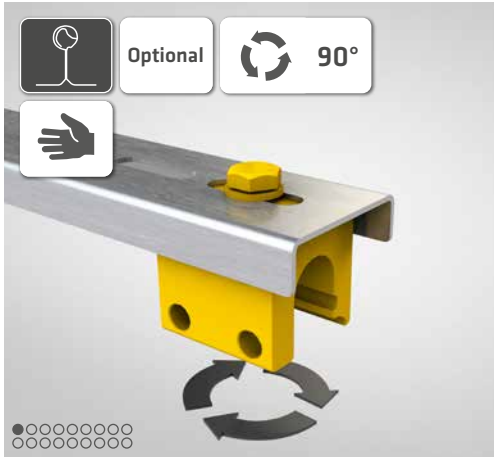

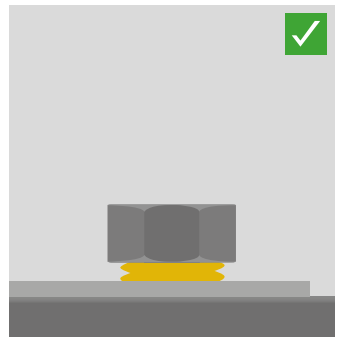
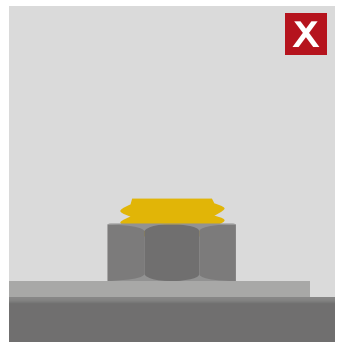
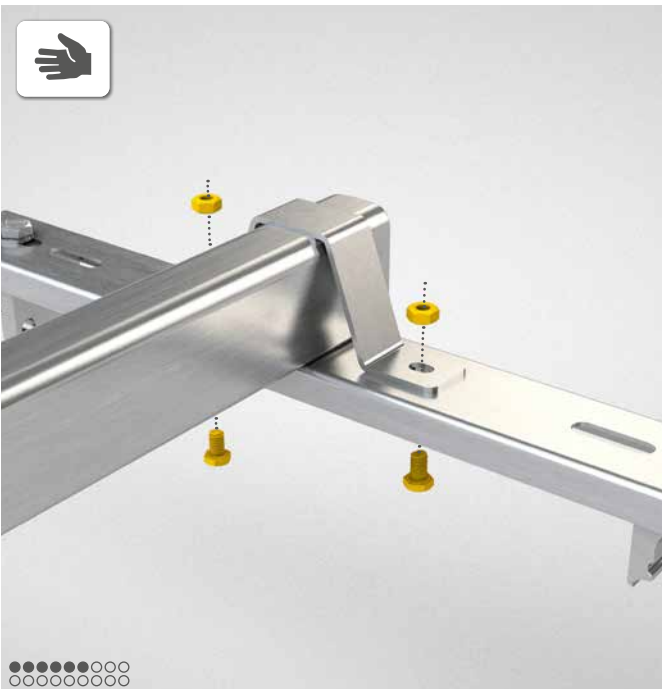
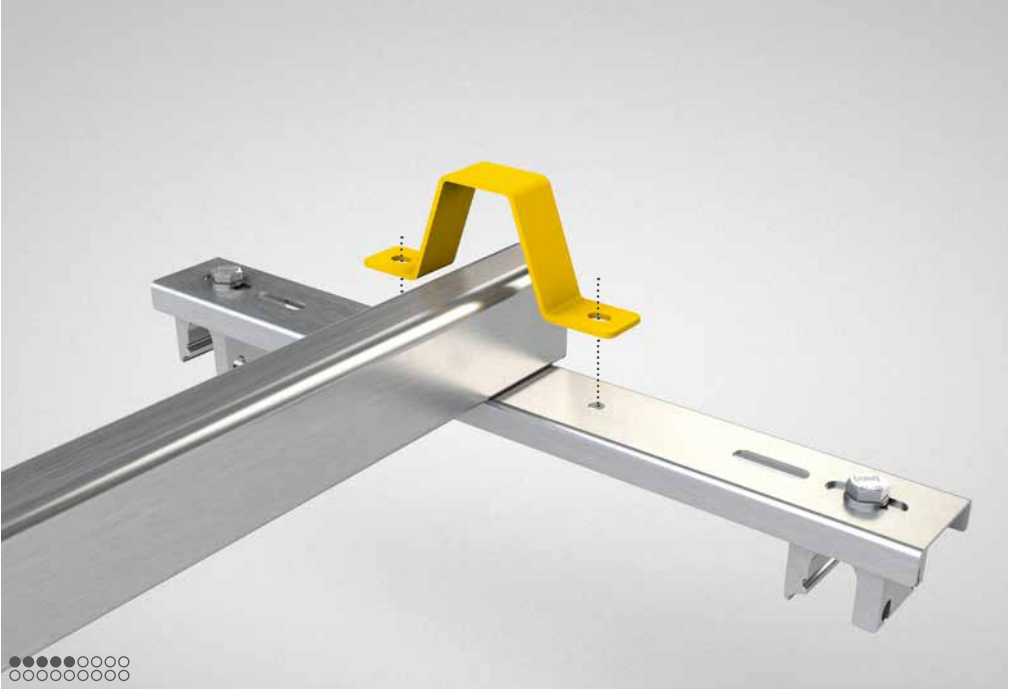





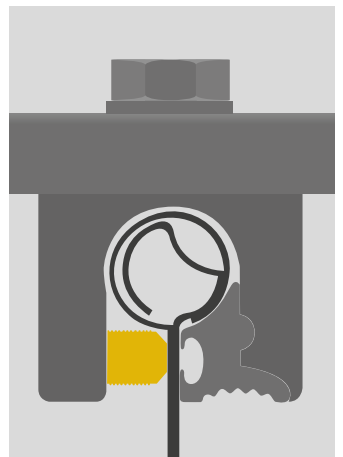
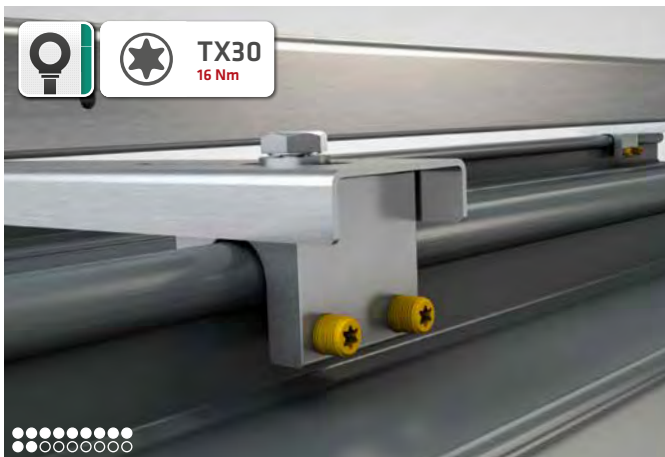
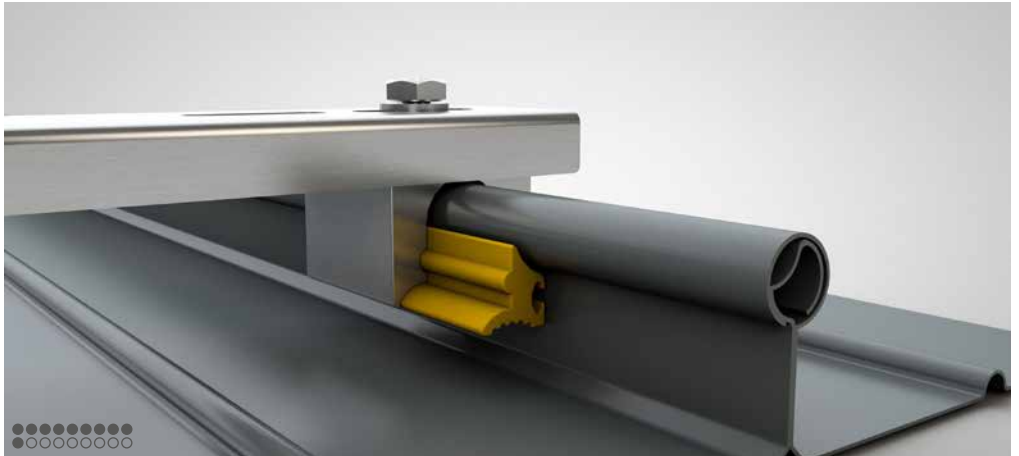
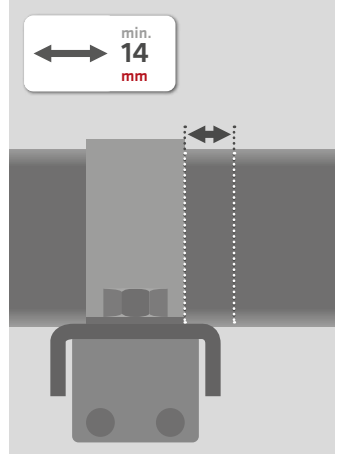





• Nm 17  
40 Nm



**ABS Guard Toeboard**  
Seite / Page 20



• Nm 13  
16 Nm







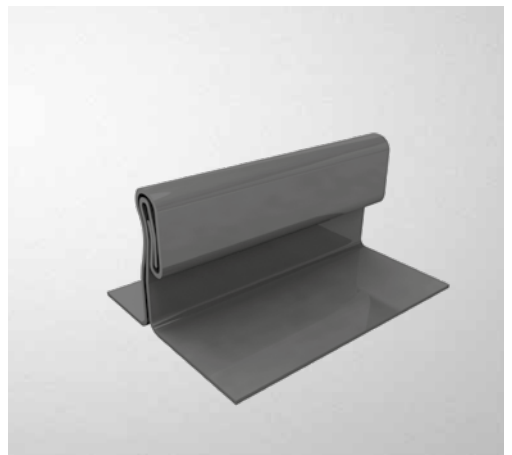
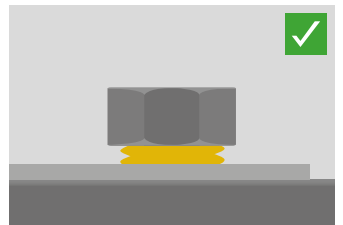
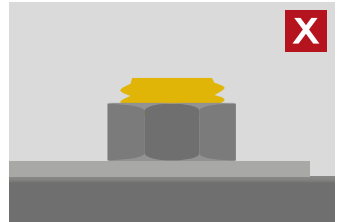
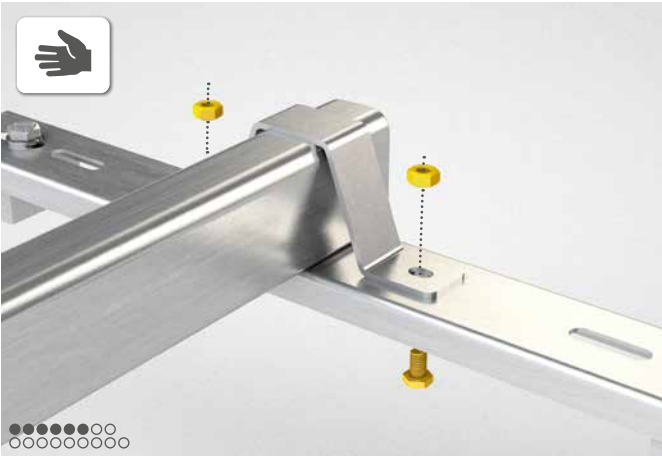
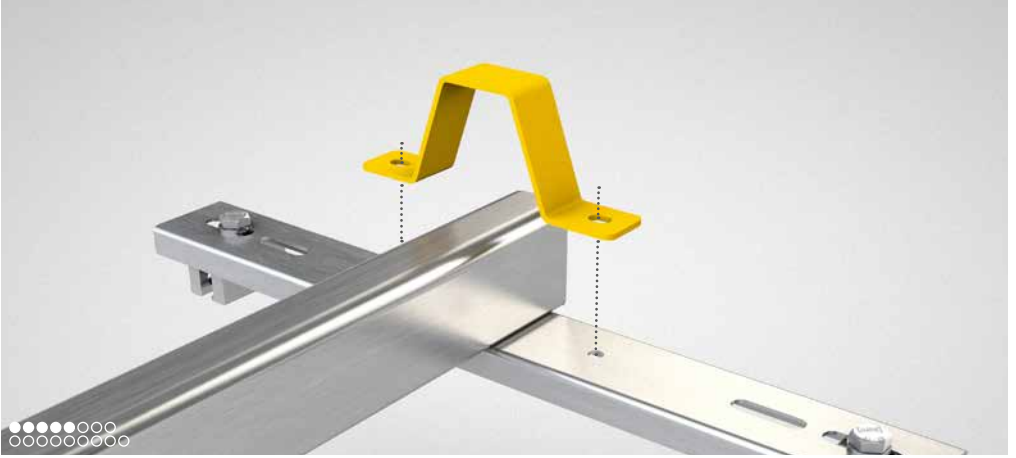

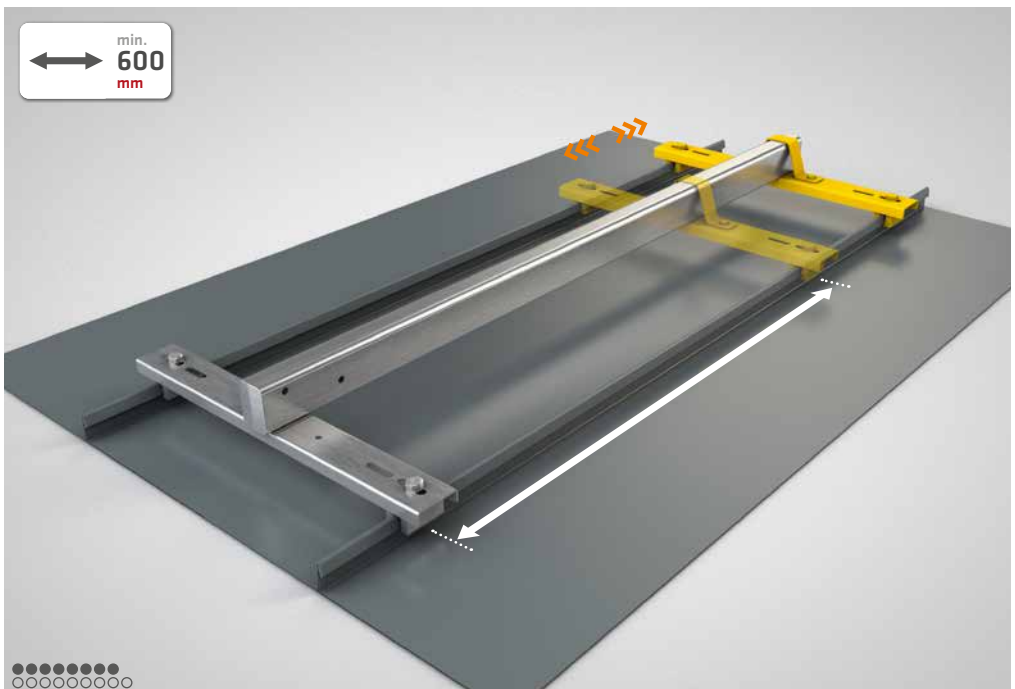
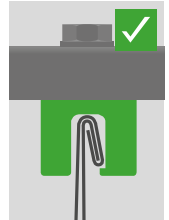
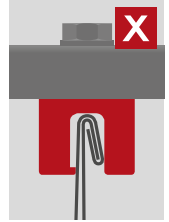
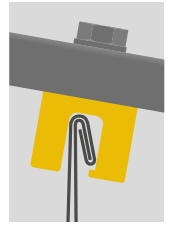

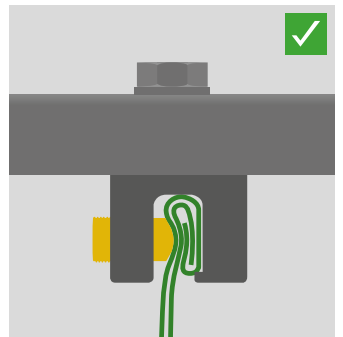
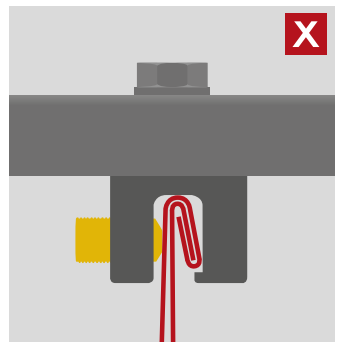
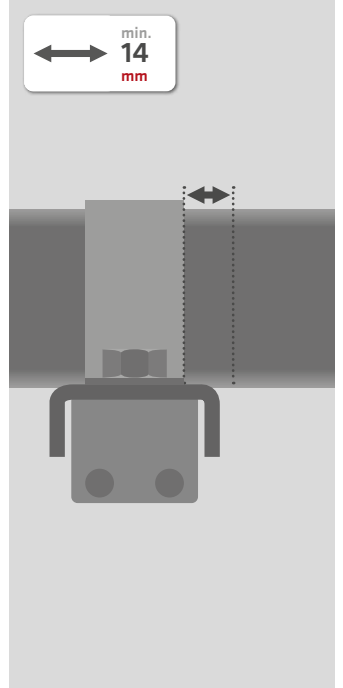



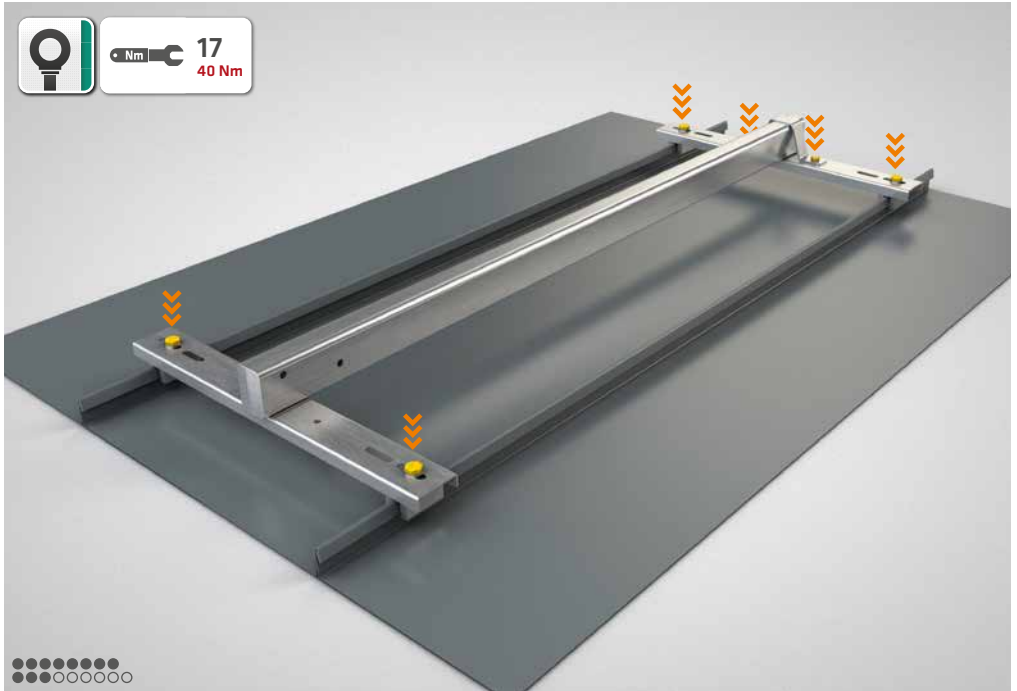





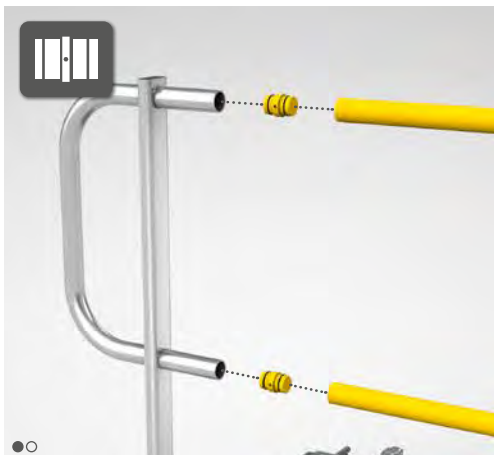

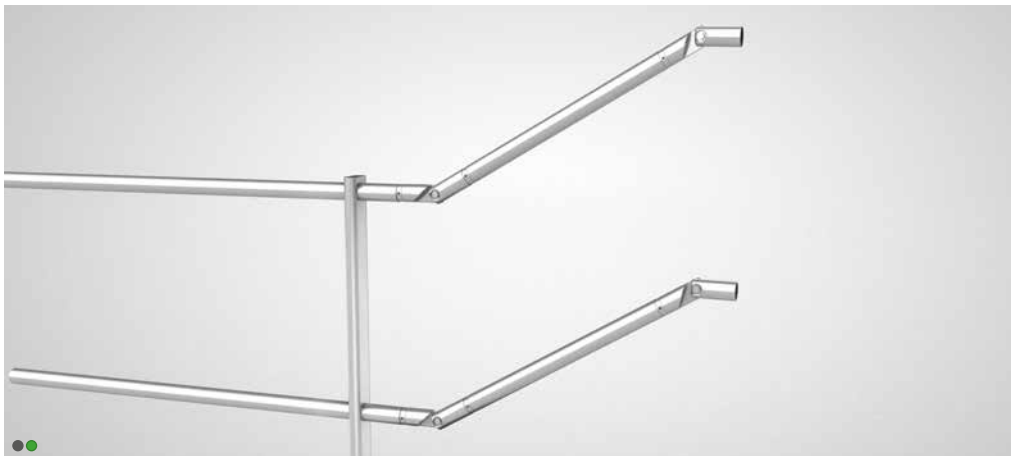
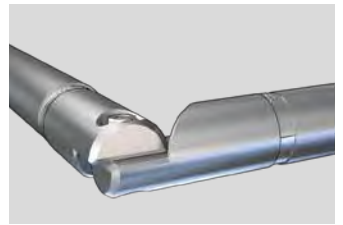
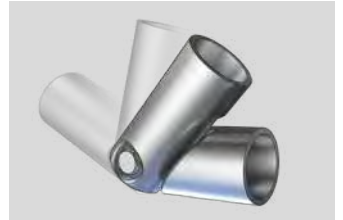

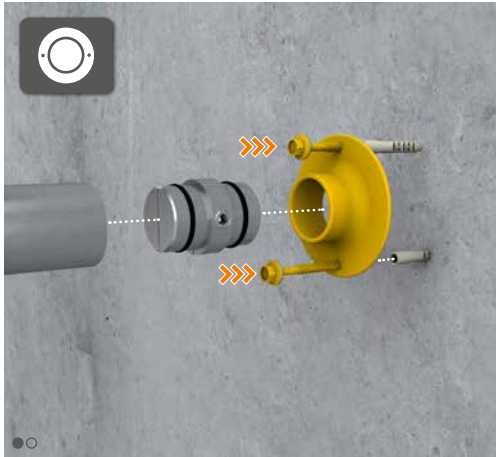

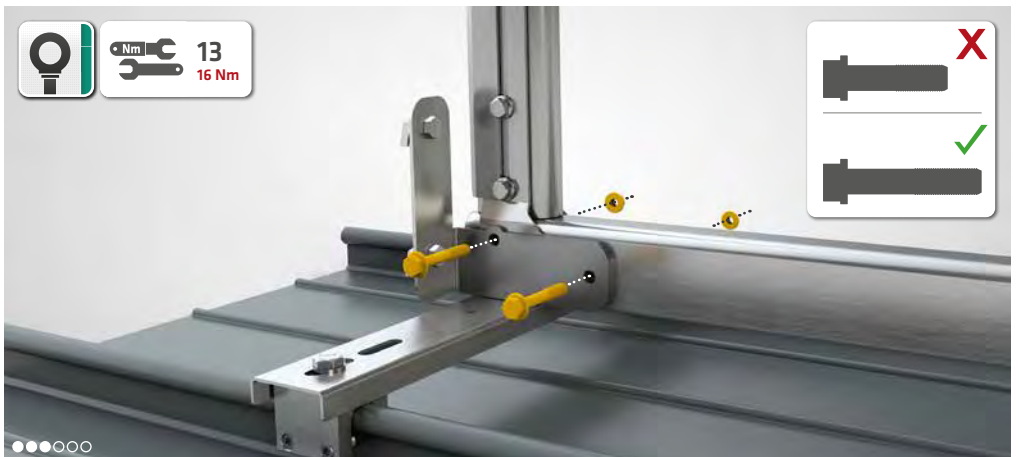



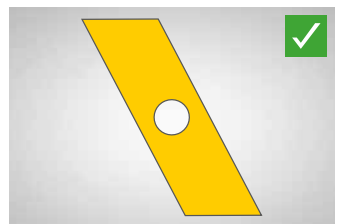
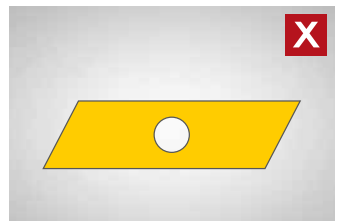
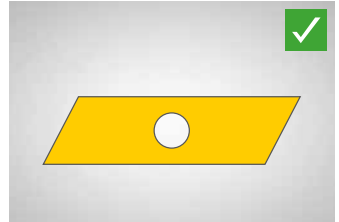
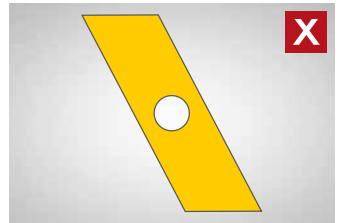

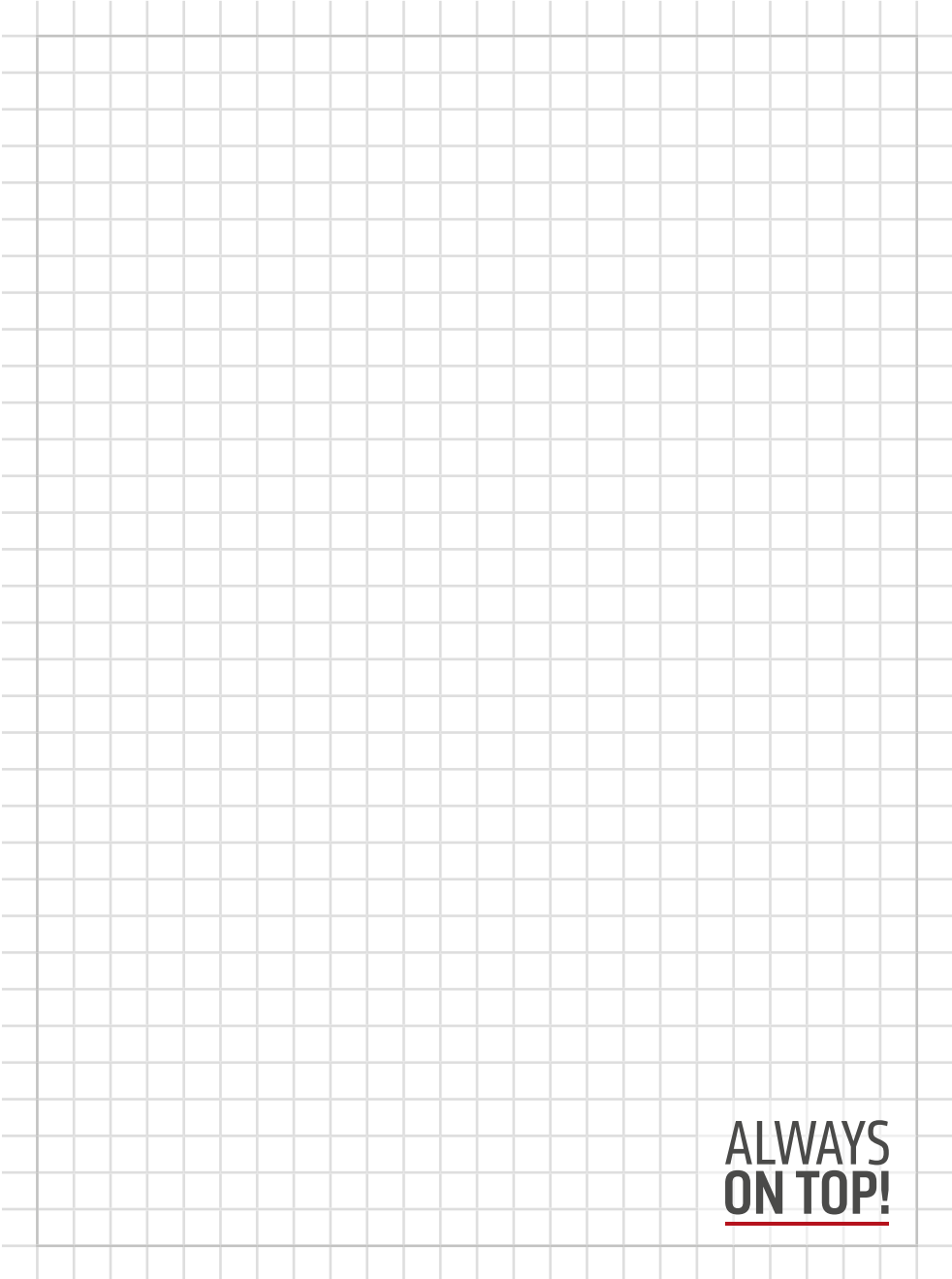

**ALWAYS  
ON TOP!**



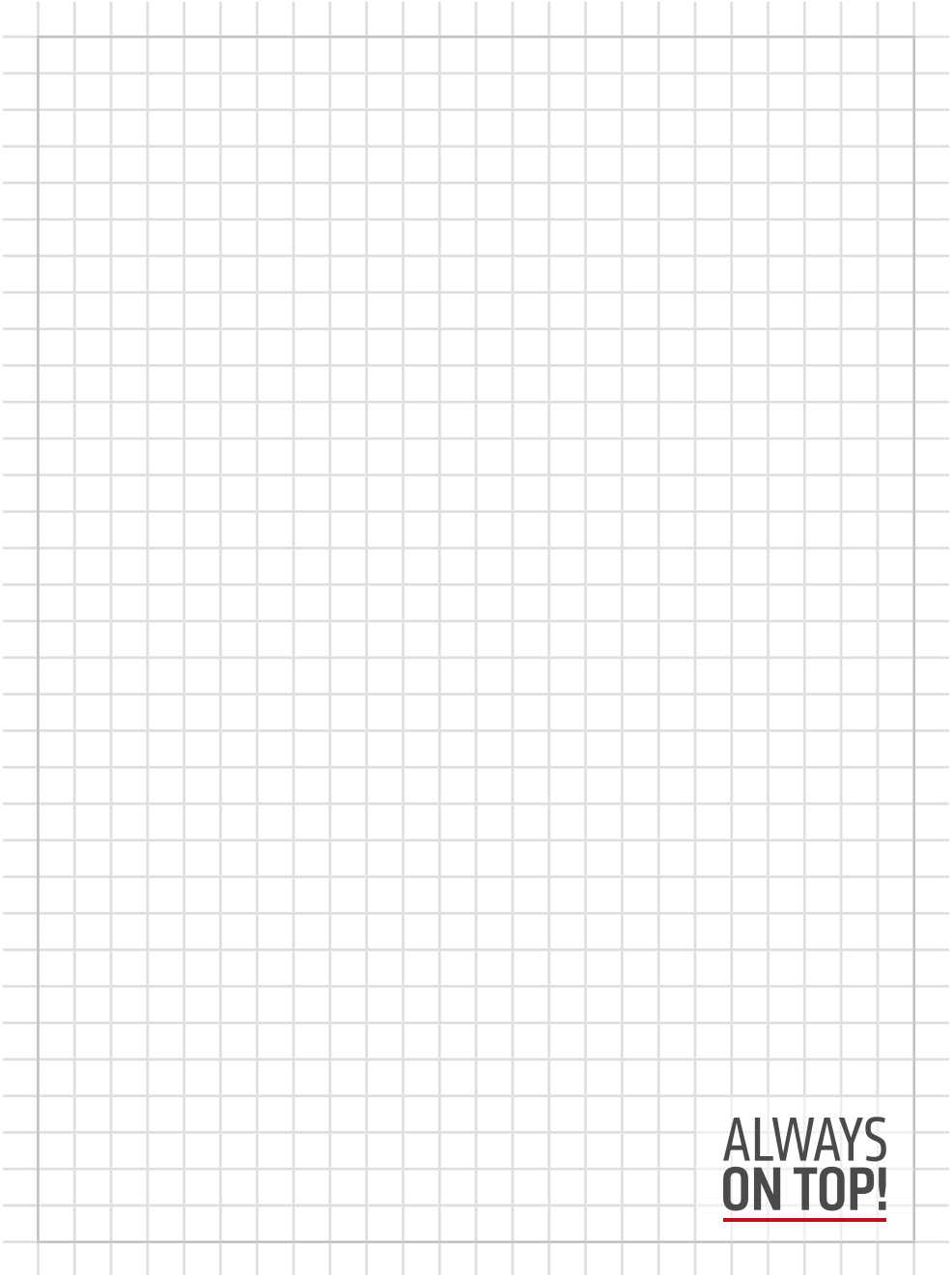

**ALWAYS  
ON TOP!**

# ALWAYS ON TOP!

## ABS Safety GmbH

Gewerbering 3  
D-47623 Kevelaer  
Germany

Tel.: +49 28 32 972 81 - 0  
Fax: +49 28 32 972 81 - 285

[info@absturzsicung.de](mailto:info@absturzsicung.de)

 [www.absturzsicung.de](http://www.absturzsicung.de)

 [.de/en](http://.de/en)

 [.de/fr](http://.de/fr)

 [.de/nl](http://.de/nl)

RS 7/4 Januar 2022



[instagram.com/abssafety](https://www.instagram.com/abssafety)



[youtube.com/abssafetygmbh](https://www.youtube.com/abssafetygmbh)



[facebook.com/ABS.Safety](https://www.facebook.com/ABS.Safety)