

ABS Solar Guard mobile

für ABS Base Fusion



MoA 319-02



DIN EN
13374
2019-A

Inhalt | Content



06



07



08



09



10



14



20



24



27

Montageschritte dokumentieren

Document assembly step



Dokumentation mit Bildern vervollständigen!
Complete your documentation using pictures!

**Dokumentation
ist Pflicht!**
Documentation is compulsory!

Optional

P Abstellbereich
Parking zone



MoA 315
ABS Base Fusion

a max. 2000mm

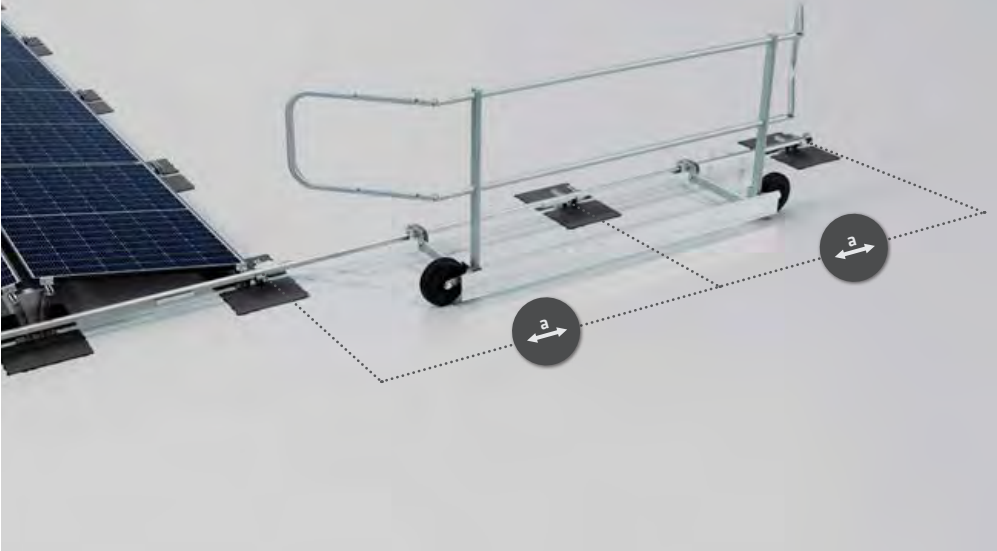

b max. 200mm



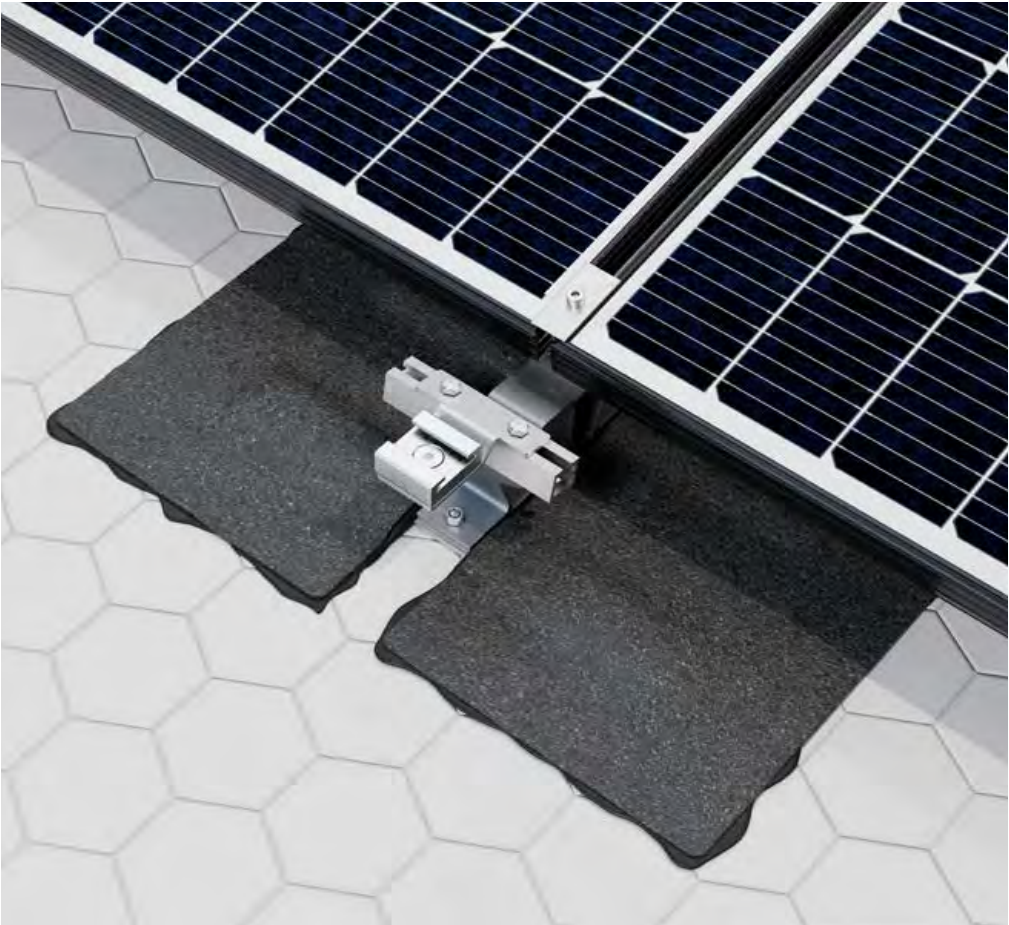

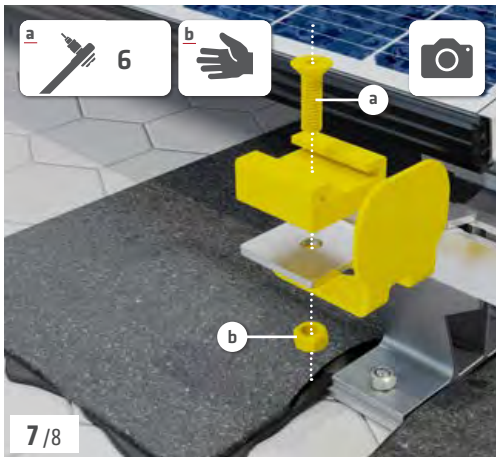
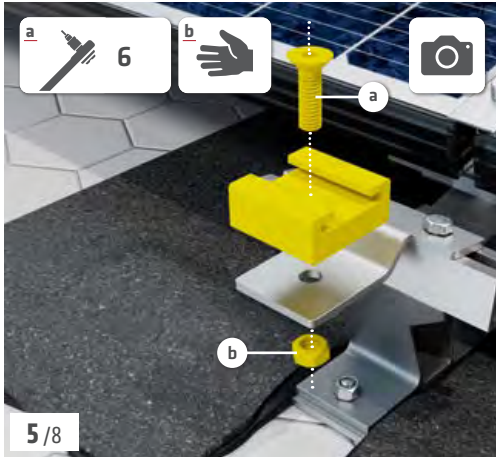
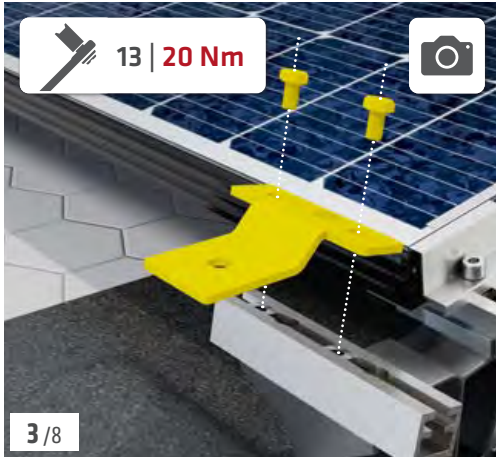

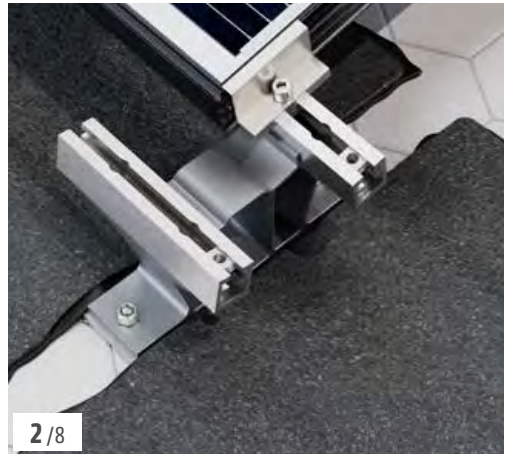
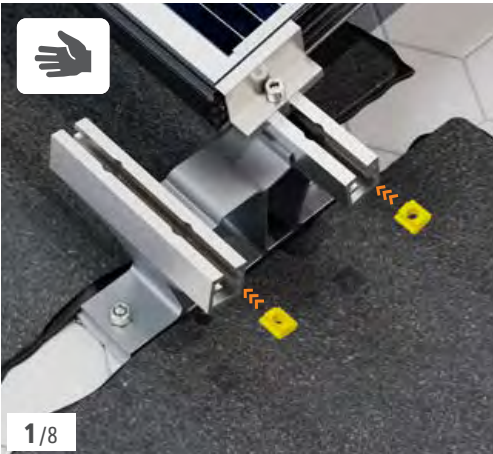

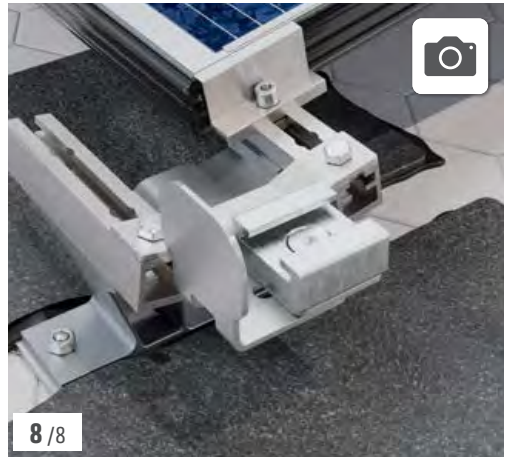
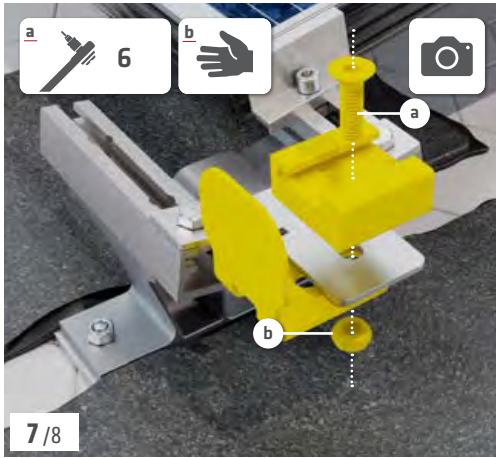
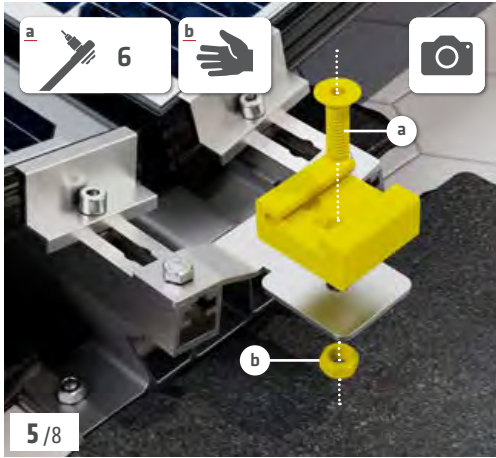
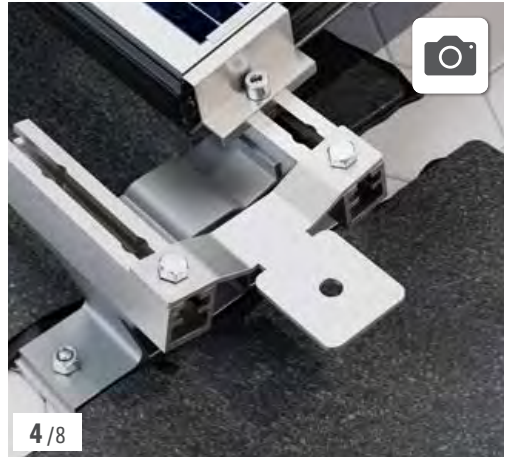
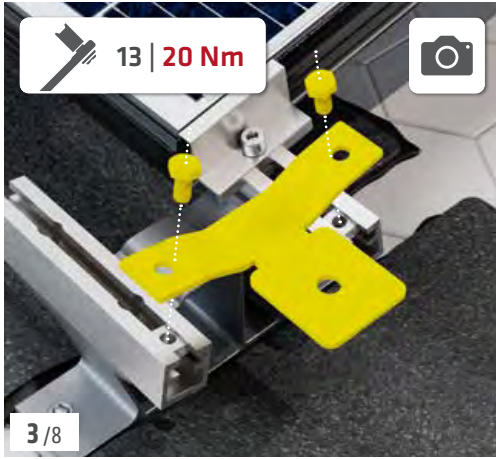



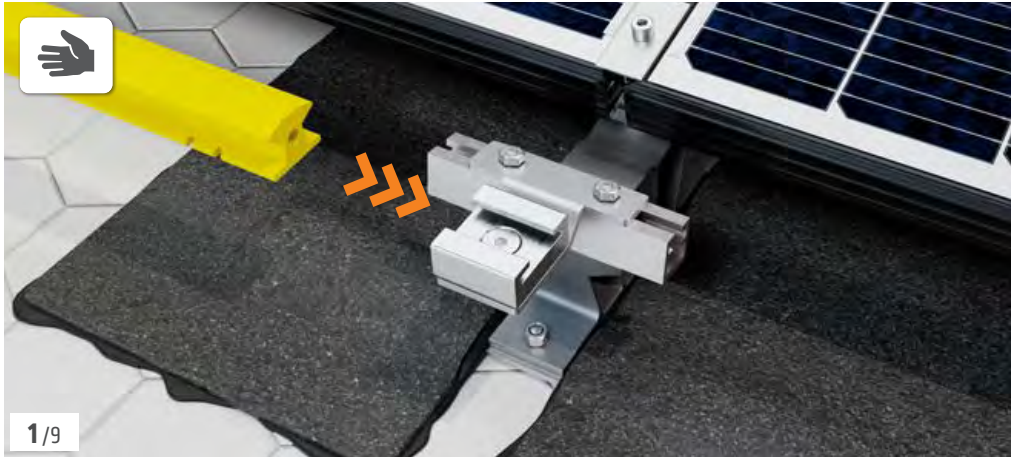

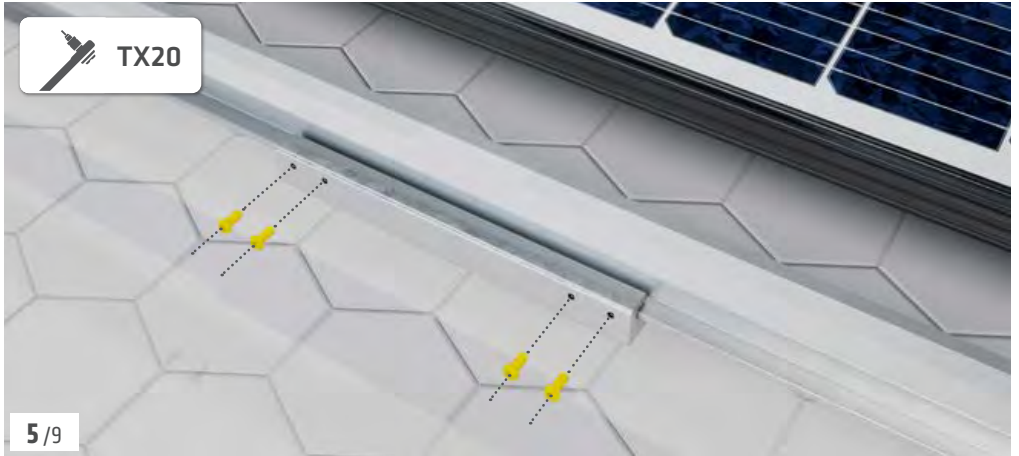

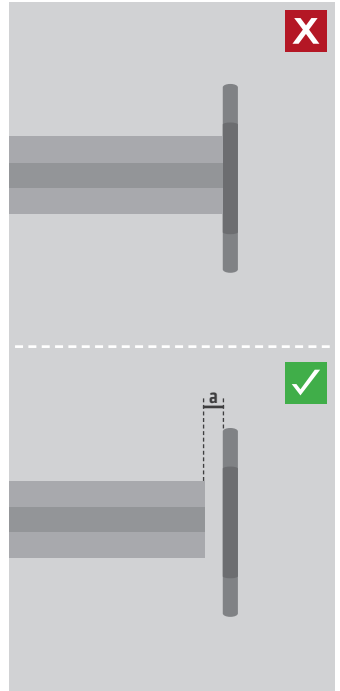
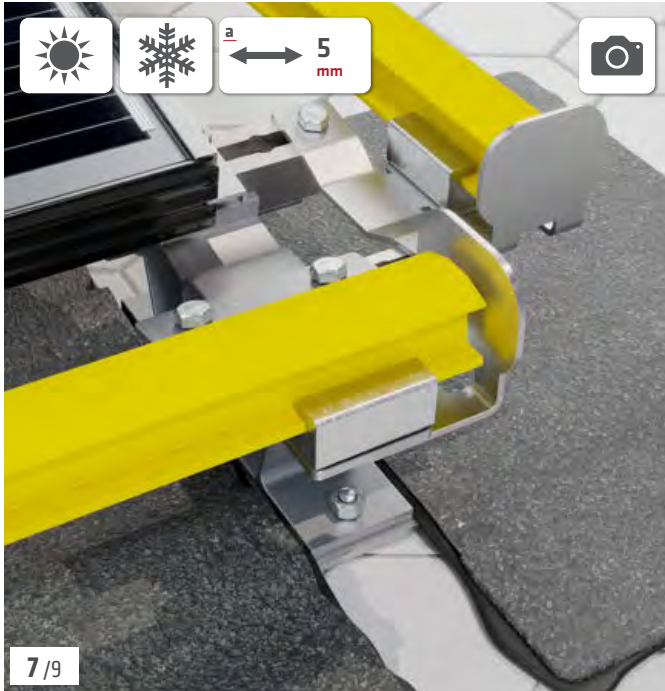



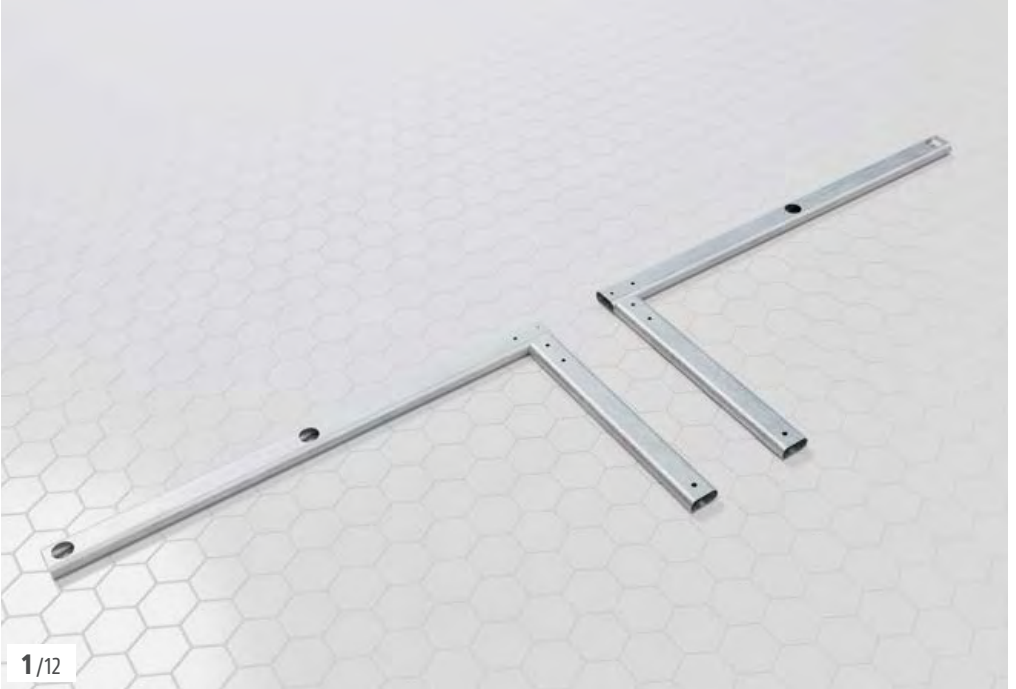

1/12

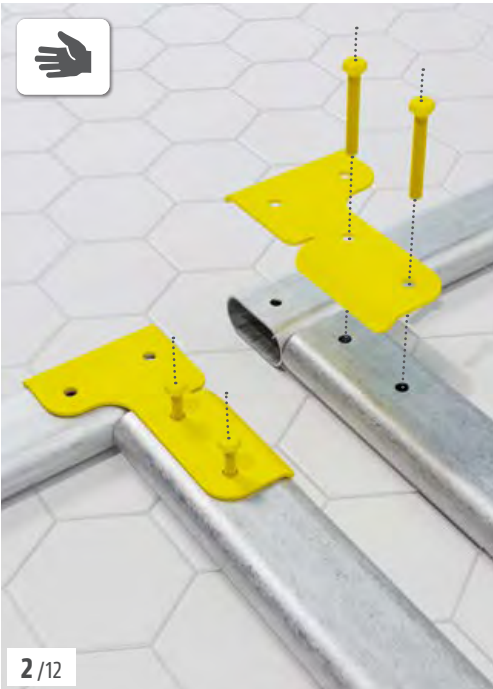

2/12



3/12

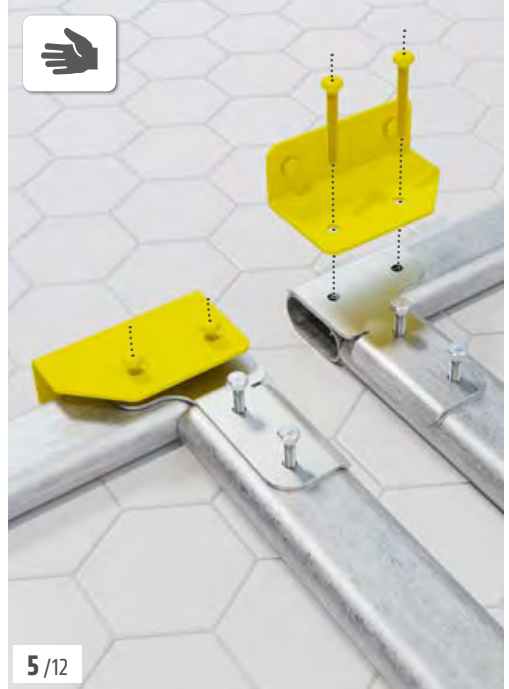
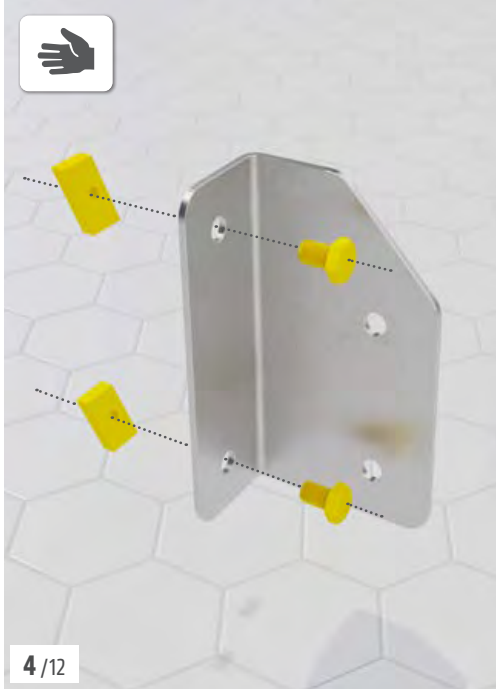

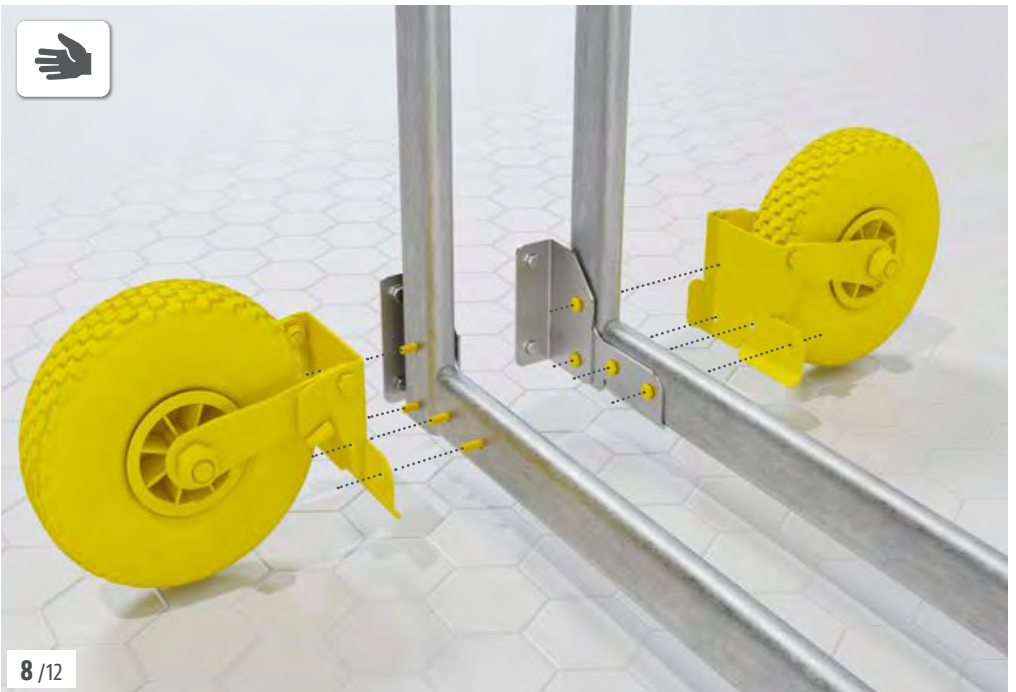

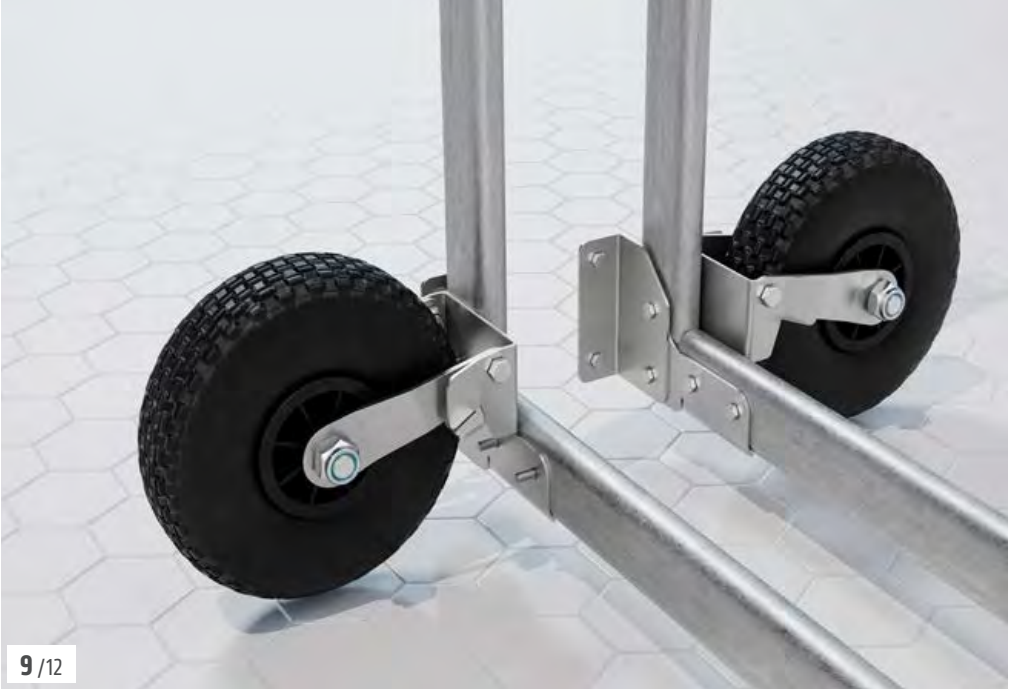

9 / 12



10 / 12





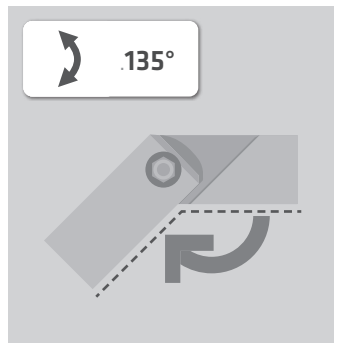

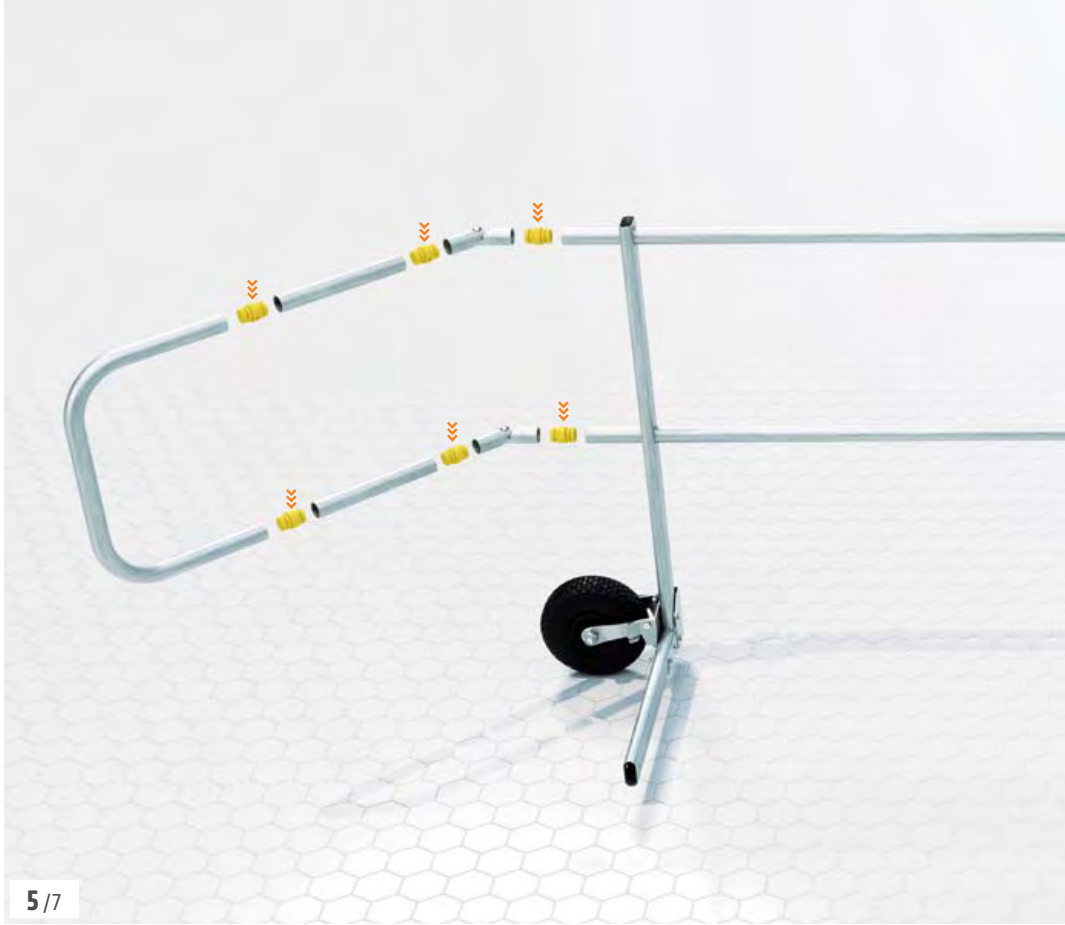

5/7

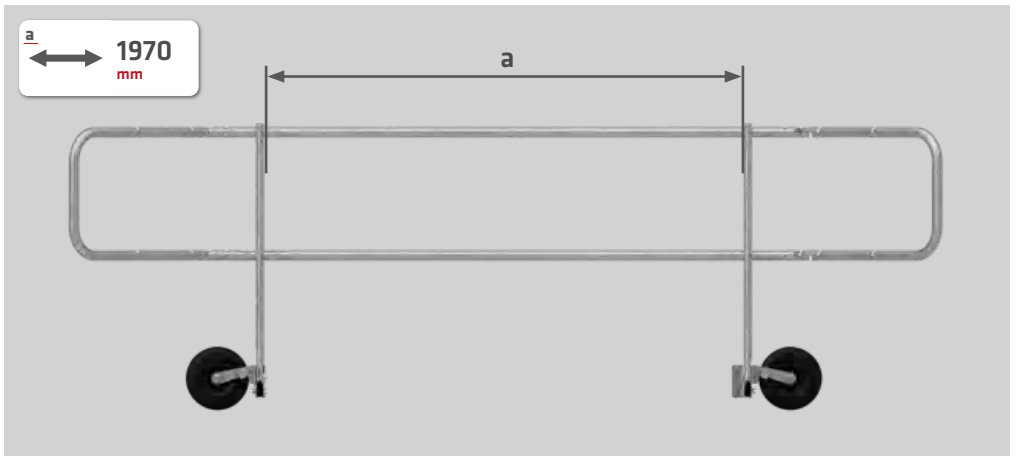

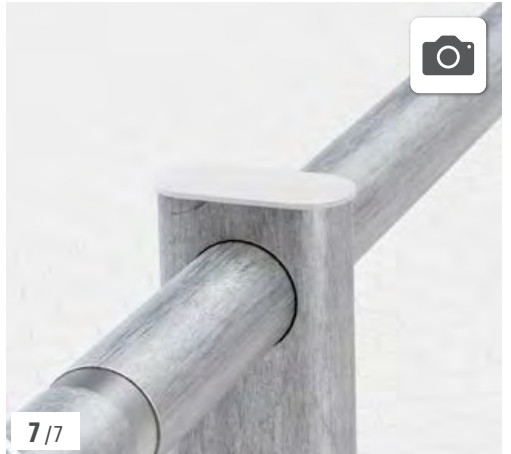





1/7

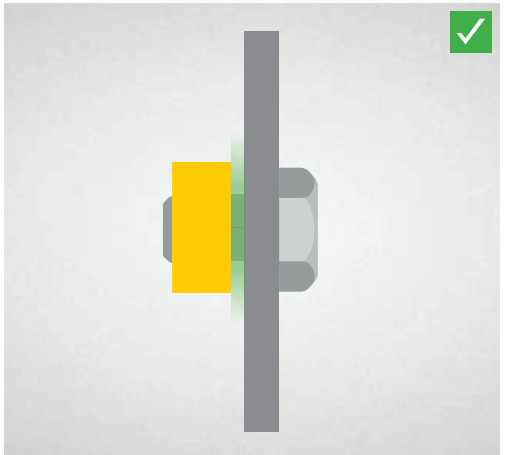
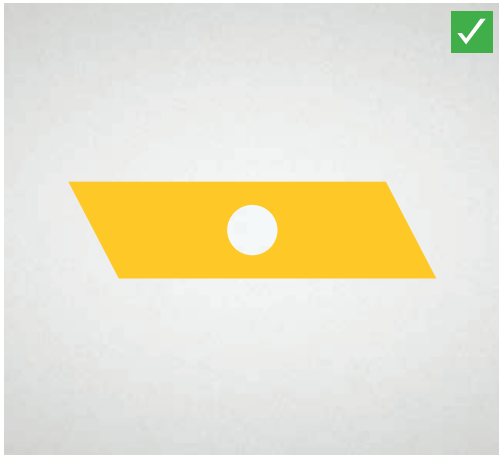



2 / 7



3 / 7

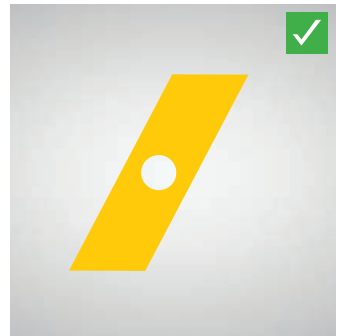
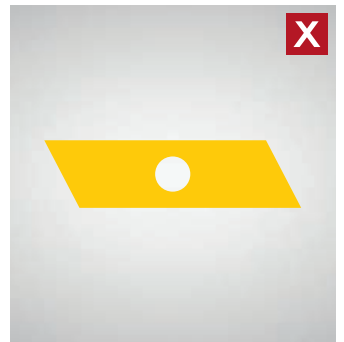



4 / 7

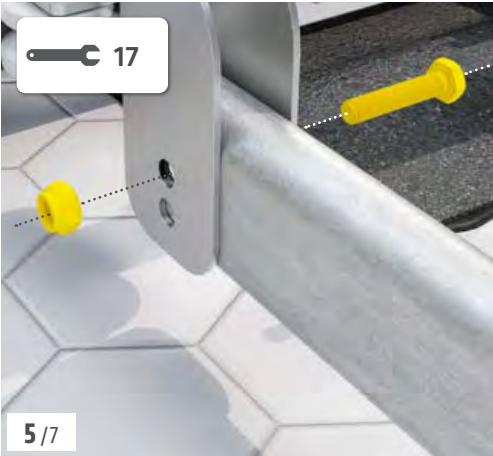

5 / 7

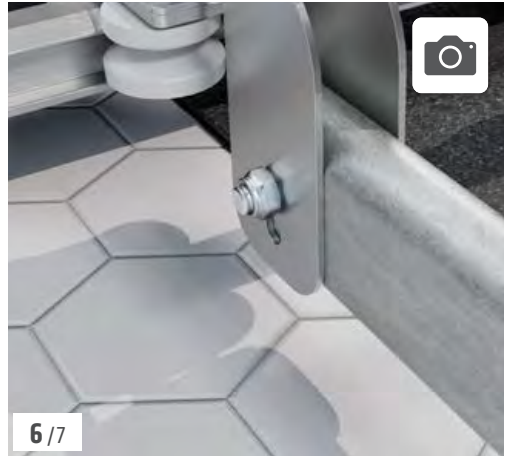

6 / 7

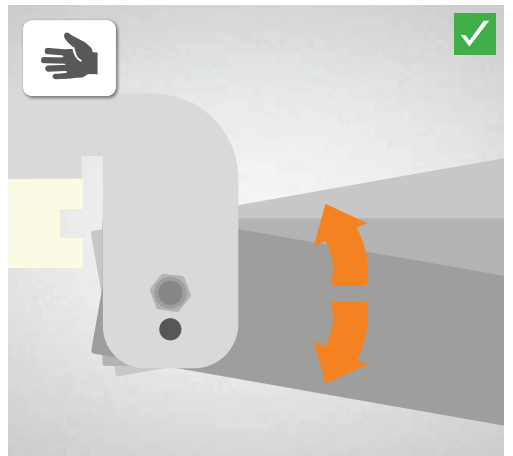
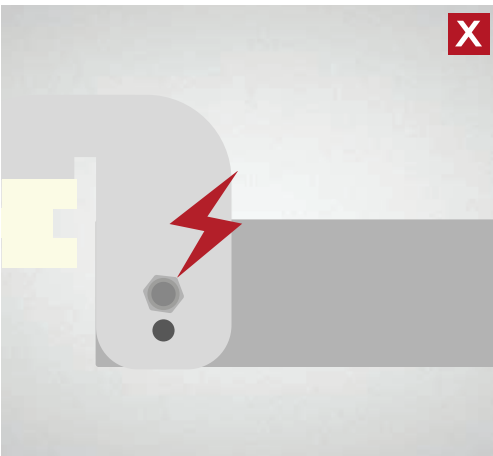









ALWAYS ON TOP!

ABS Safety GmbH

Gewerbering 3
D-47623 Kevelaer
Germany

Tel.: +49 28 32 972 81 - 0
Fax: +49 28 32 972 81 - 285

info@absturzschutz.de

 www.absturzschutz.de

 .de/en

 .de/fr

 .de/nl

AP_22_April 2024



[instagram.com/abssafety](https://www.instagram.com/abssafety)



[youtube.com/abssafetygmbh](https://www.youtube.com/abssafetygmbh)



[facebook.com/ABS.Safety](https://www.facebook.com/ABS.Safety)



[linkedin.com/company/abs-safety-gmbh](https://www.linkedin.com/company/abs-safety-gmbh)



[xing.com/pages/abssafetygmbh](https://www.xing.com/pages/abssafetygmbh)