

# [ABS]

## ABS Steigleiter

SL2-XXX

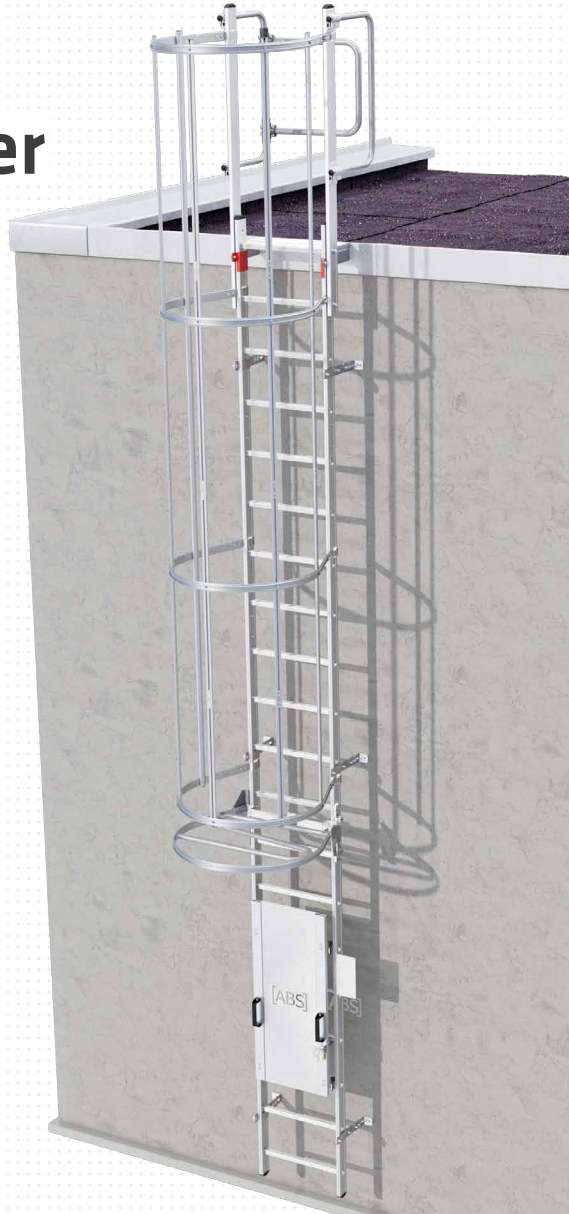

DIN EN  
ISO 14122-4:  
2016-10

DIN  
14094-1

DIN  
18799-1  
18799-3



ÖNORM Z  
1600:  
2008-02



MoA 330-09



## Werkzeuge | Tools



## Sicherheitshinweise | Safety instructions



- DE** Montageanleitung beachten (1) und Sicherheitshinweise beachten (2).
- EN** Comply with the installation manual (1) and Comply with the safety instructions (2).
- FR** Respecter la notice de montage (1) and Respecter les consignes de sécurité (2).
- NL** Montagehandleiding in acht nemen (1) and Veiligheidsinstructies in acht nemen (2).
- BGR** Спазвайте инструкциите за монтаж (1) and Спазвайте инструкциите за безопасност (2).
- DK** Følg monteringsvejledningen (1) and Følg sikkerhedshenvisningerne (2).
- ET** järgige paigaldusjuhendit (1) ja ohutusjuhiseid (2).
- FI** Noudata asennusohjeita (1) and Noudata turvallisuusohjeita (2).
- IT** Rispettare le istruzioni di montaggio (1) and Rispettare le istruzioni di sicurezza (2).
- PL** Przestrzegać zaleceń instrukcji montażu (1) and Przestrzegać zasad bezpieczeństwa (2).
- SK** Dodržujte návod na montáž (1) and Dodržujte bezpečnostné pokyny (2).
- SL** Sledite navodilom za namestitve (1) and Sledite varnostnim navodilom (2).
- ES** Observar las instrucciones de montaje (1) and Observar las indicaciones de seguridad (2).
- CS** Dodržujte návod k montáži (1) and Dodržujte bezpečnostní pokyny (2).
- HU** Vegye figyelembe az összeszerelési útmutatót (1) and Vegye figyelembe a biztonsági utasításokat (2).

Für eine ordnungsgemäße Montage ist eine Dokumentation des Einbaus zwingend erforderlich!  
For a proper installation, a complete documentation of assembly is absolutely necessary.

## Kontakte | Contact persons

**Vertrieb & Technische Beratung**  
Sales & Technical Support

+49 (0) 28 32 - 972 81 - 0  
vertrieb@absturzschutz.de

### Schulung

Training  
+49 (0) 28 32 - 972 81 - 148  
schulung@absturzschutz.de

### Montagevorbereitung

Assembly  
+49 (0) 28 32 - 972 81 - 260  
service@absturzschutz.de

## Mustertypenschild | Sample label

<b>[ABS]</b>	<b>ABS SAFETY GMBH</b> Kevelaer, Germany info@absturzschutz.de www.absturzschutz.de		
<b>Typ / Produktbezeichnung</b> Typ / Produktbezeichnung		<b>Chargennummer /</b> Batch number	
<b>6</b> Normen / Standards	<input type="checkbox"/> -		
<b>7</b> Max. Nutzer gleichzeitig Max. No. of simultaneous users	<input type="checkbox"/> -		
<b>11</b> Modellnummer / Model number	<input type="checkbox"/> -		
<b>14</b> 150 kg	<input type="checkbox"/> -		
<input type="checkbox"/> -	<input type="checkbox"/> -		
<input type="checkbox"/> -	<input type="checkbox"/> -		

# Montageschritte dokumentieren

Document assembly step



Dokumentation mit Bildern vervollständigen!  
Complete your documentation using pictures!

**Dokumentation  
ist Pflicht!**

Documentation is compulsory!

**Inhalt | Content**

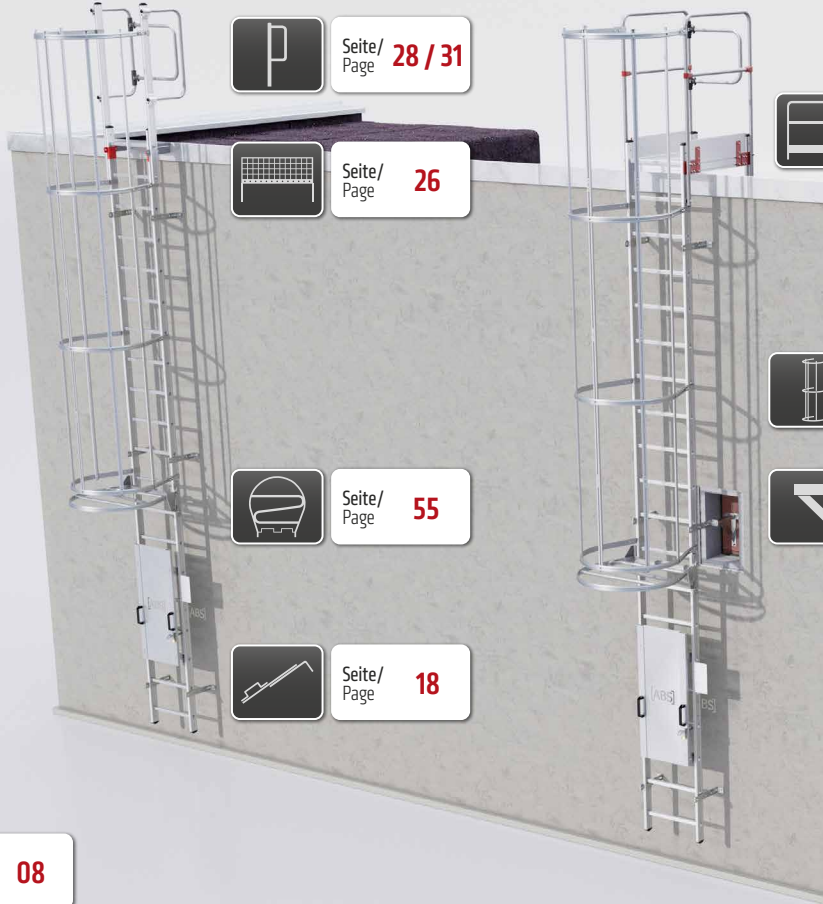

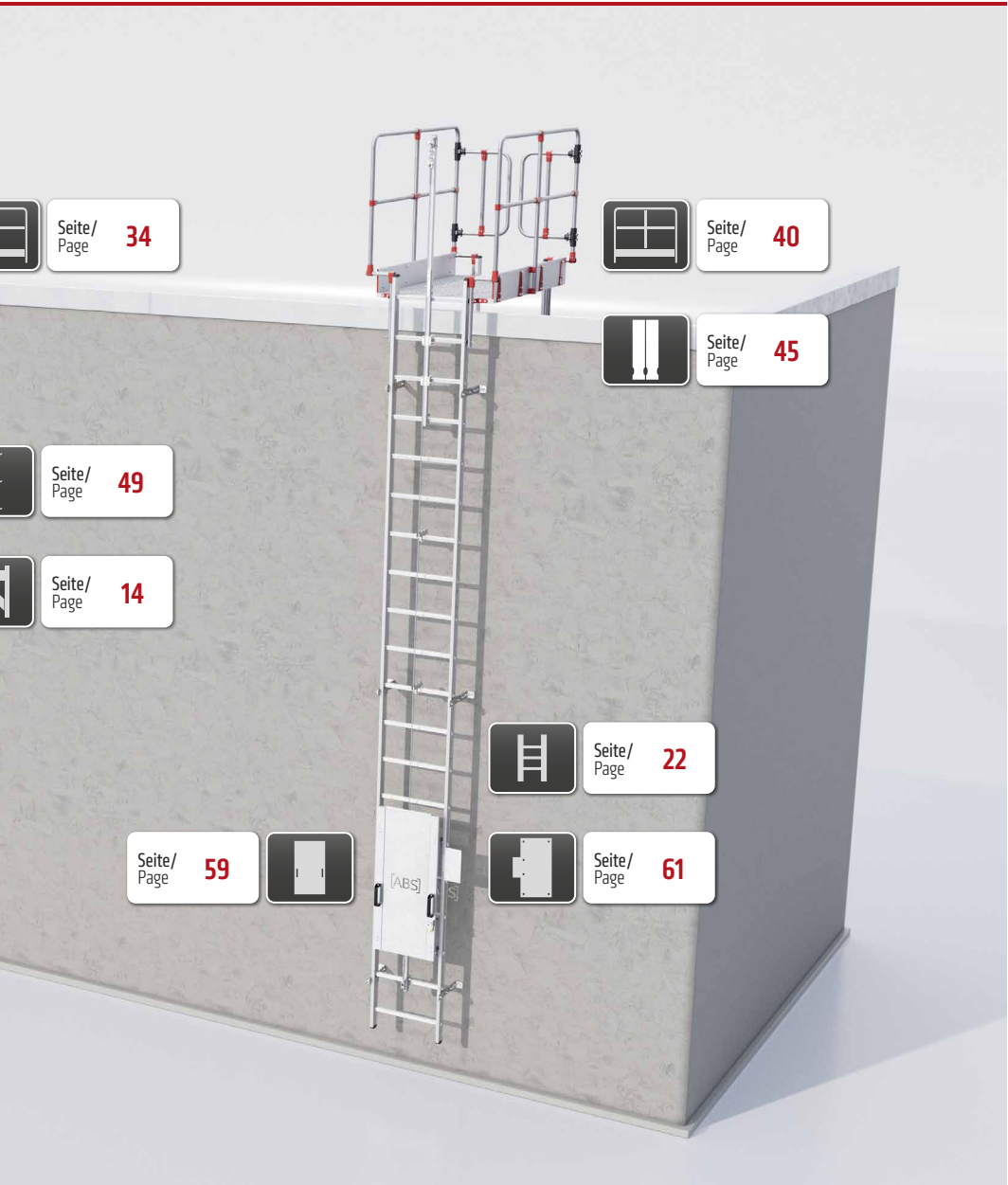

Seite/  
Page **34**



Seite/  
Page **40**



Seite/  
Page **45**



Seite/  
Page **49**



Seite/  
Page **14**



Seite/  
Page **22**

Seite/  
Page **59**



Seite/  
Page **61**

Inhalt | Content

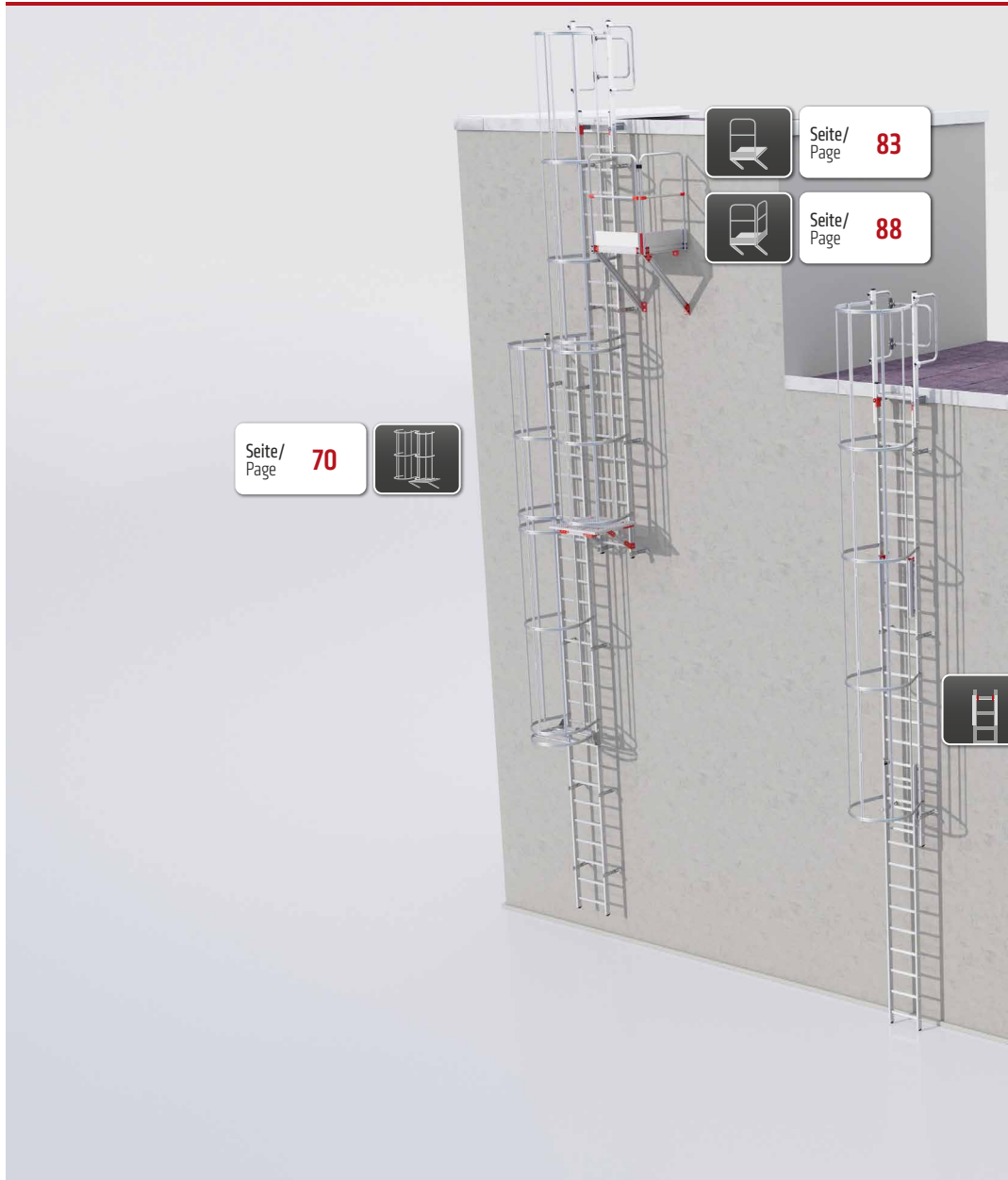

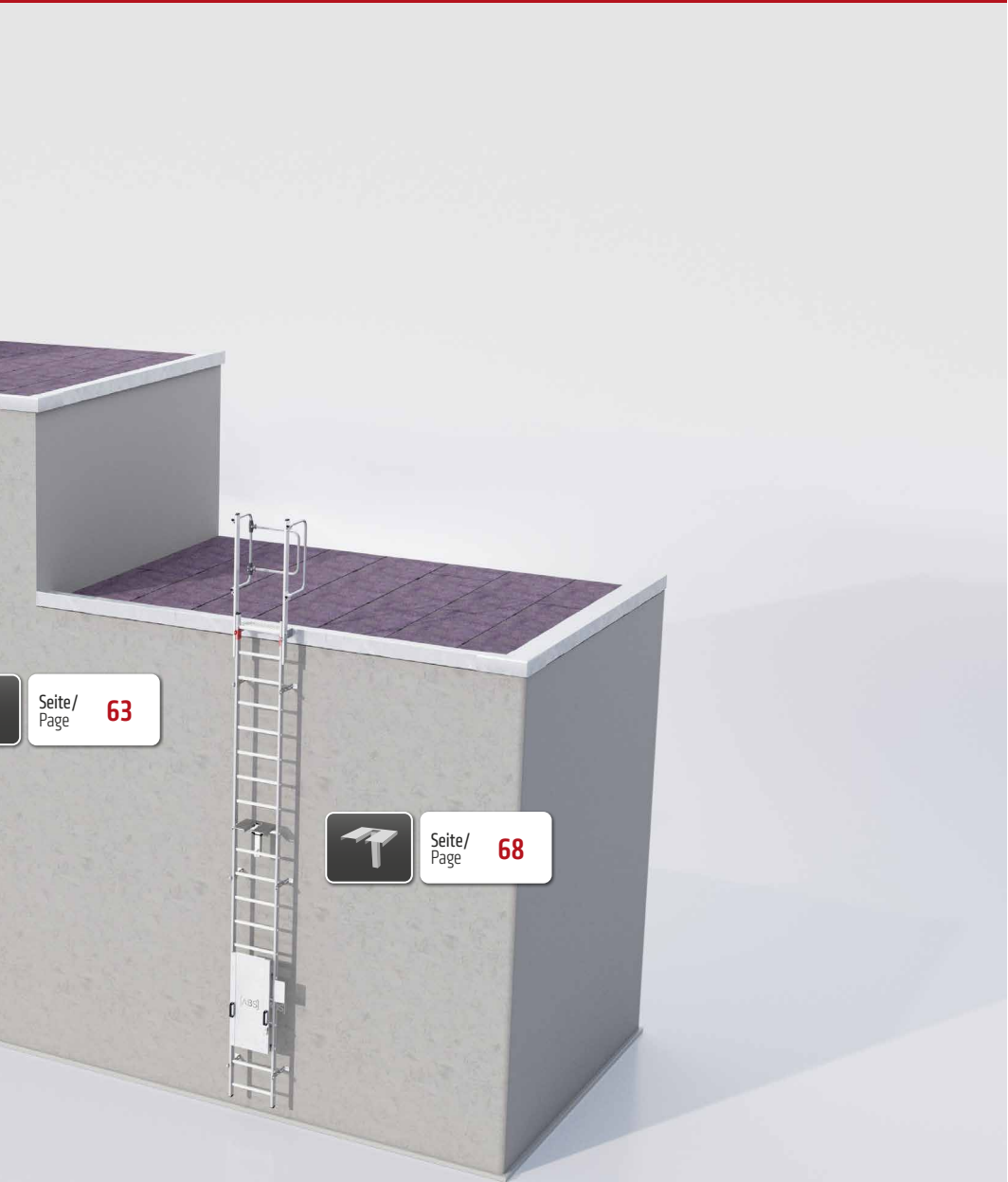

Seite/  
Page **63**



Seite/  
Page **68**

Inhalt | Content

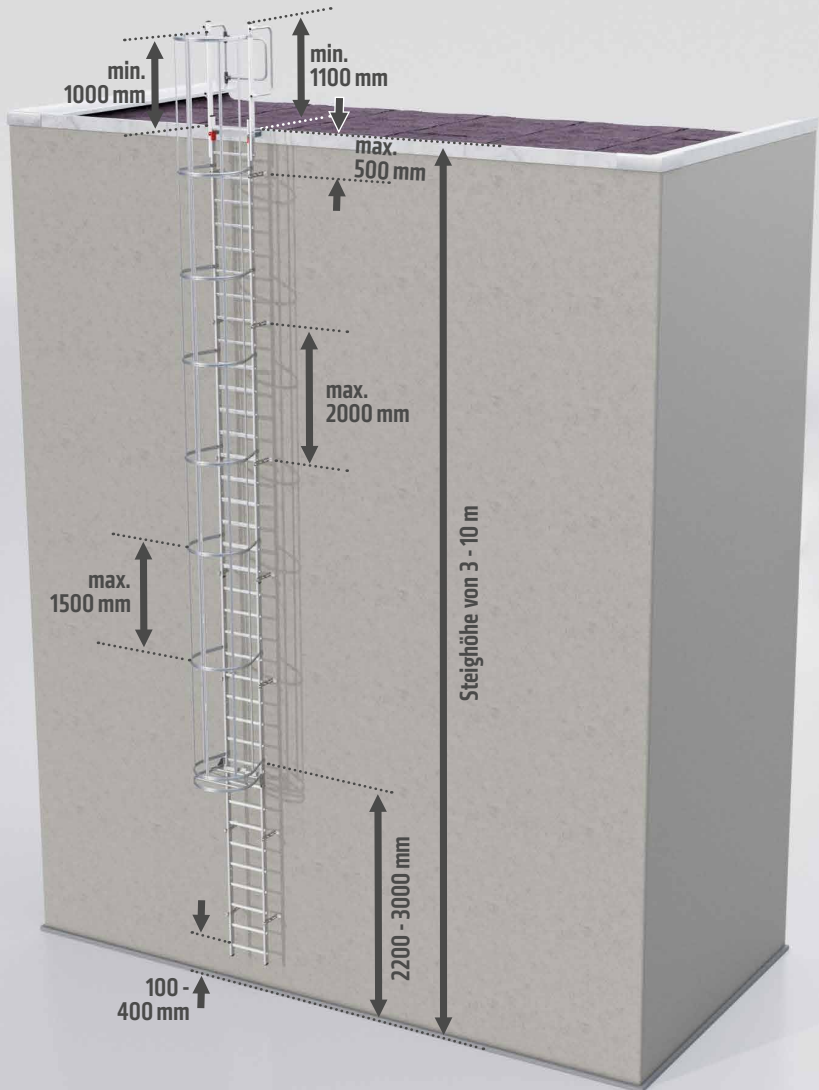

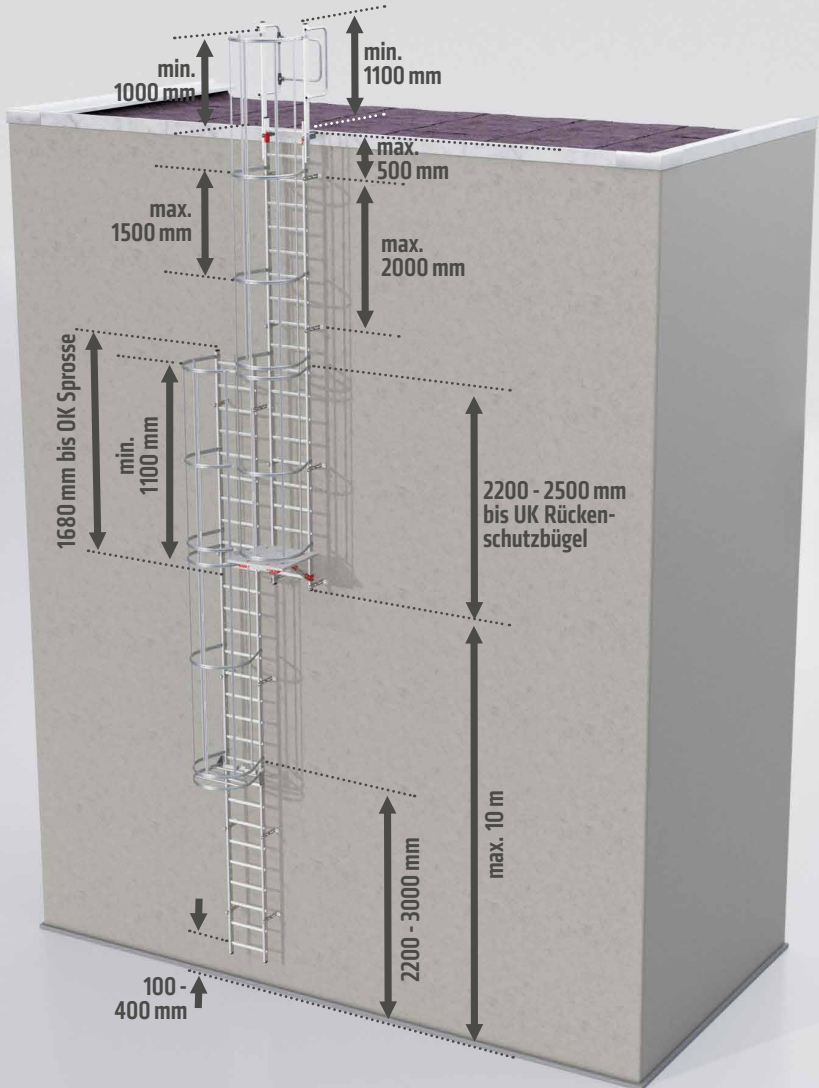

Inhalt | Content

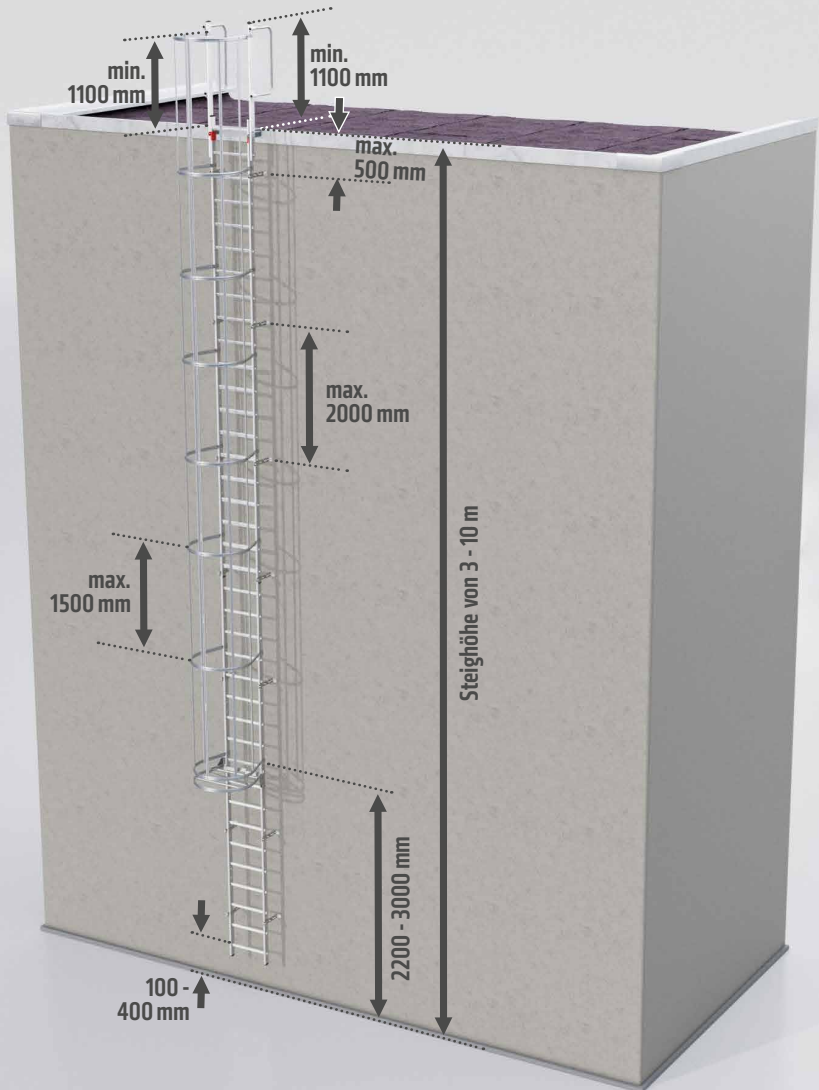

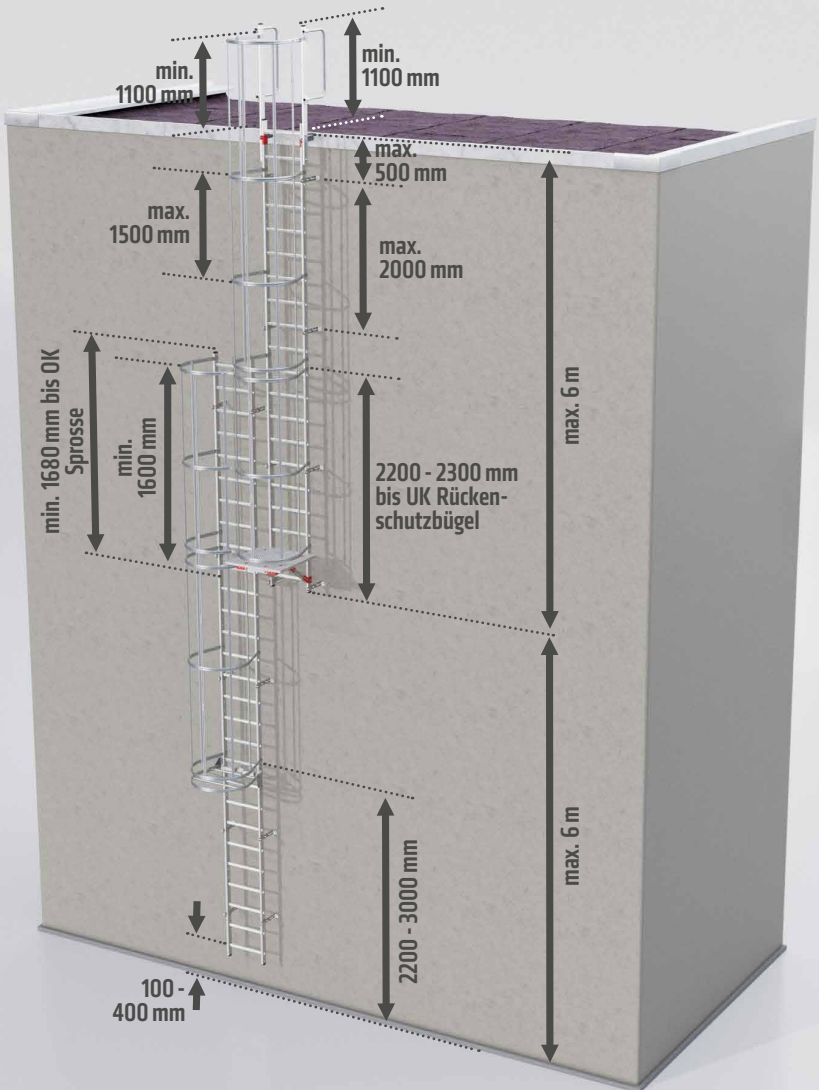

Inhalt | Content

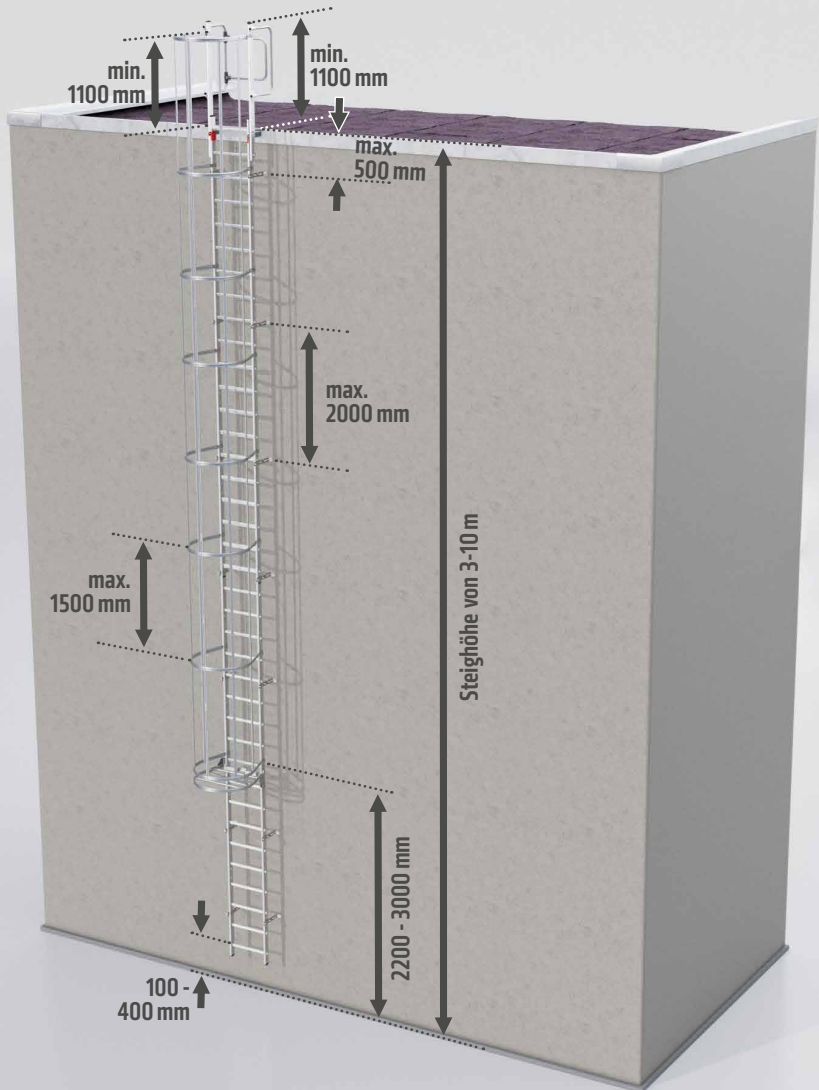

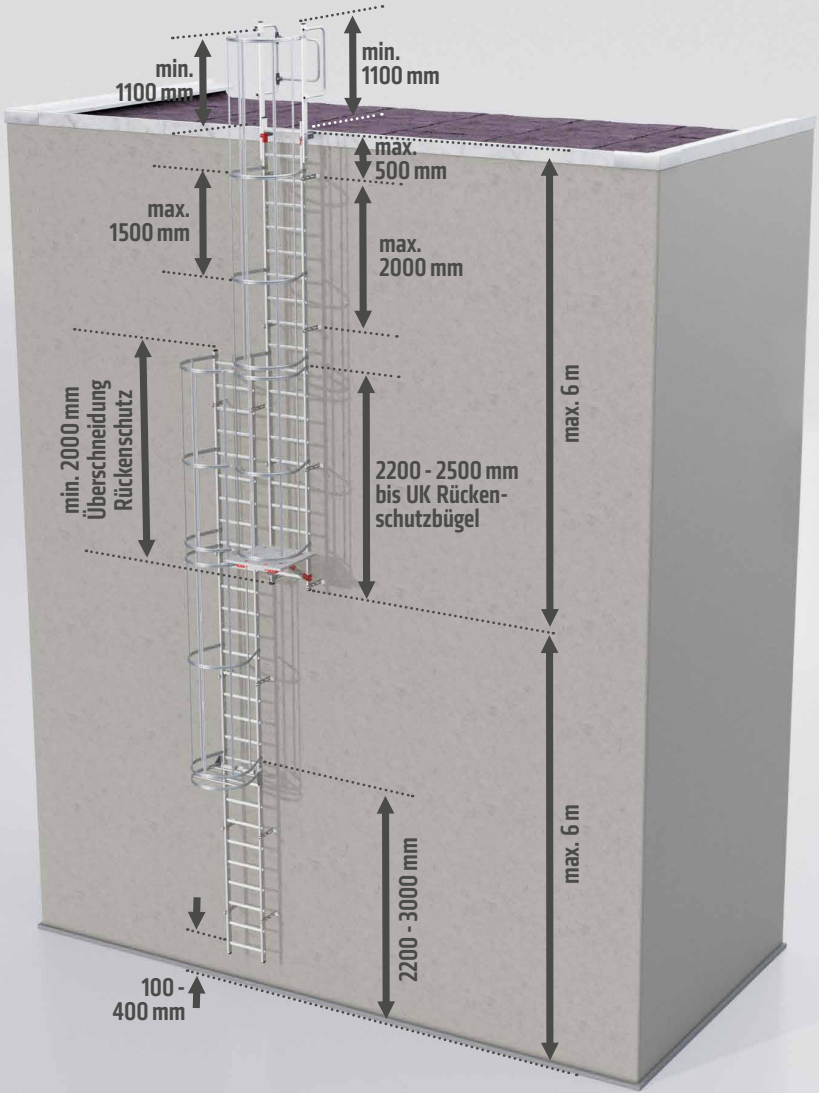

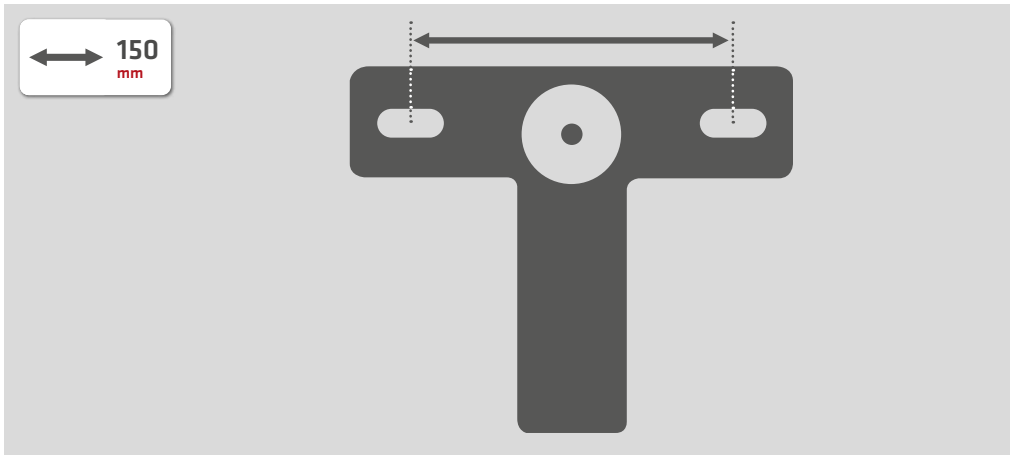

<b>UK1</b> 85 - 130 mm	<b>UK2</b> 125 - 170 mm	<b>UK3</b> 165 - 210 mm	<b>UK4</b> 205 - 250 mm	<b>UK5</b> 250 - 290 mm	<b>UK6</b> 290 - 330 mm	<b>UK7</b> 330 - 375 mm	<b>UK8</b> 375 - 420 mm



1/7

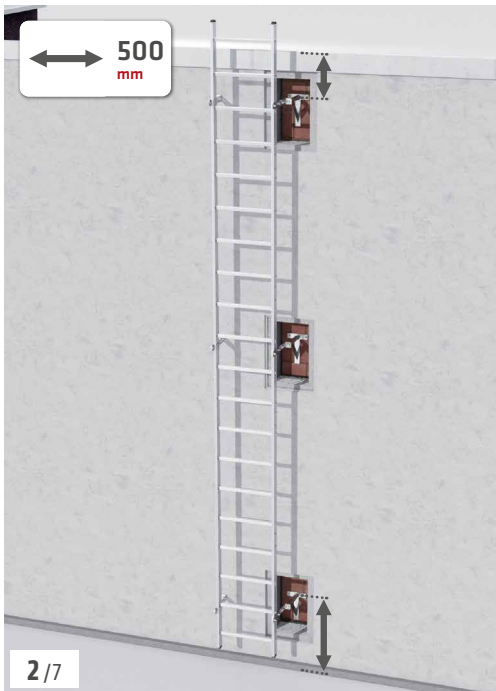

500  
mm

2/7

a 628 mm      b max. 2000 mm

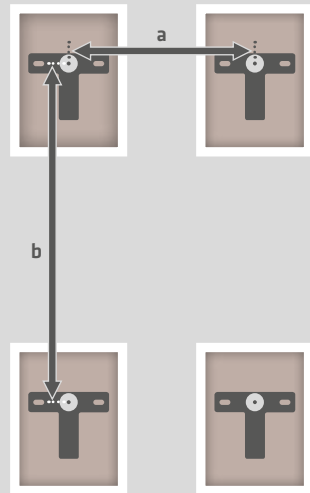



4 / 7

5 / 7

• Nm  17 | 40 Nm



6 / 7



7 / 7

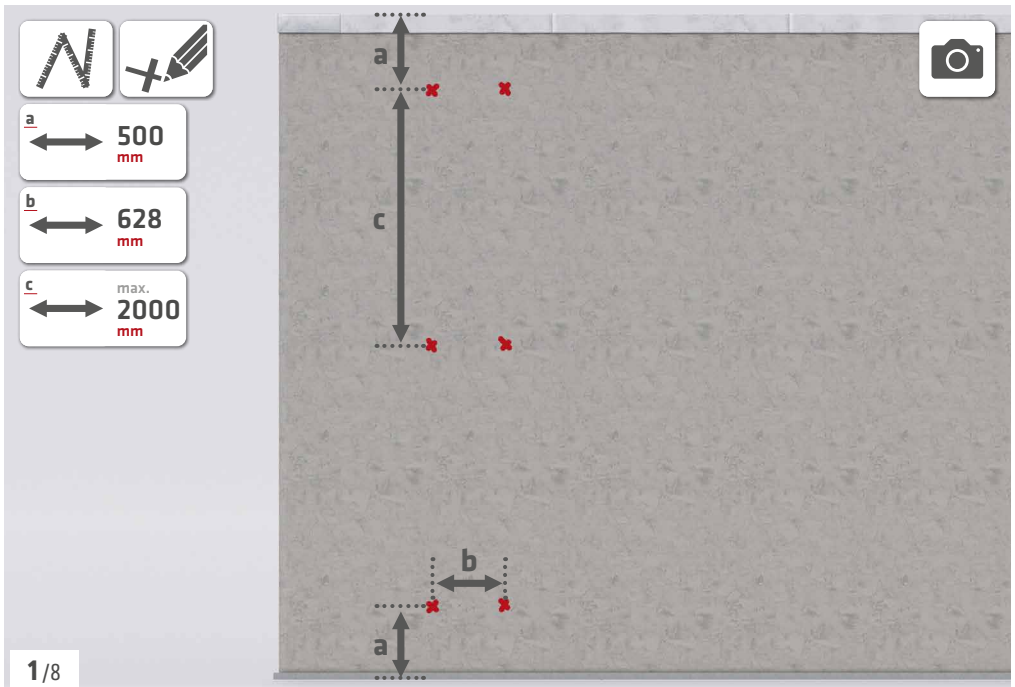

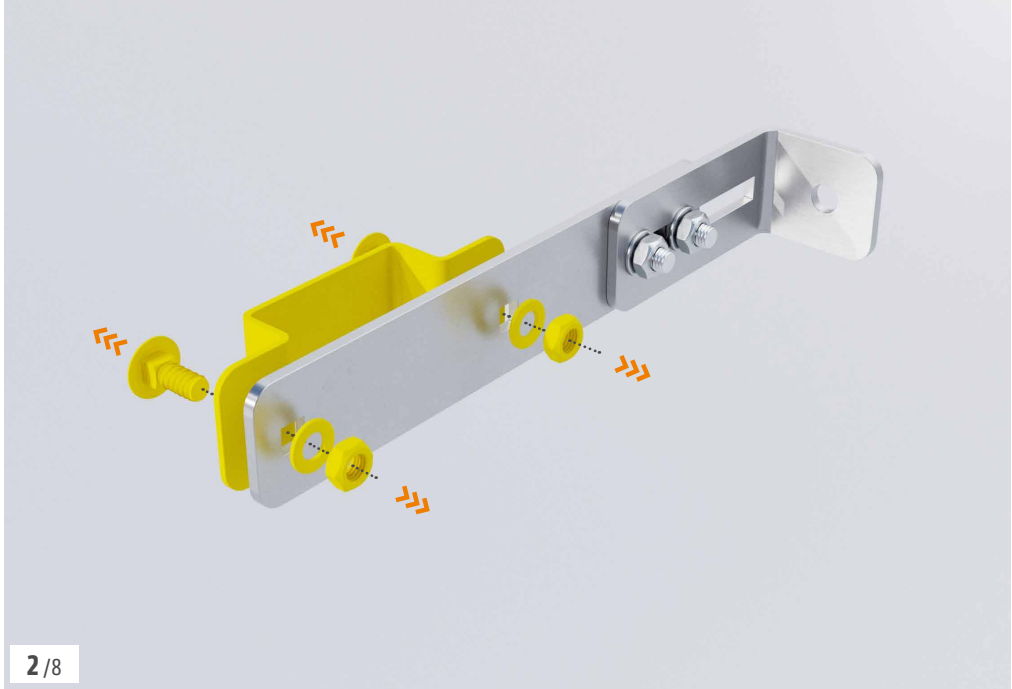

2 / 8



3 / 8



4 / 8

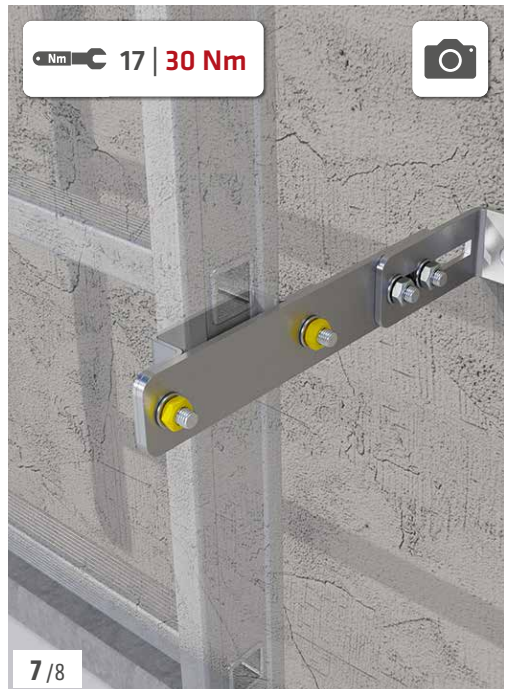
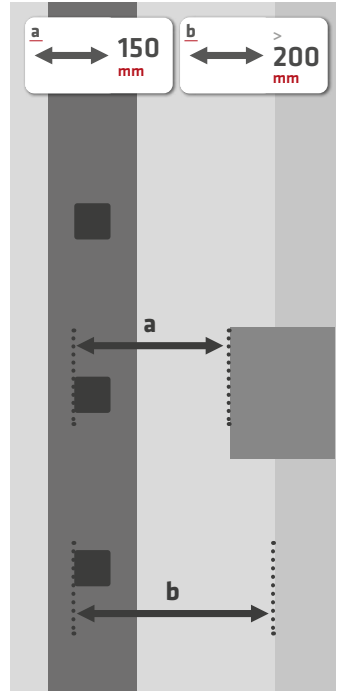
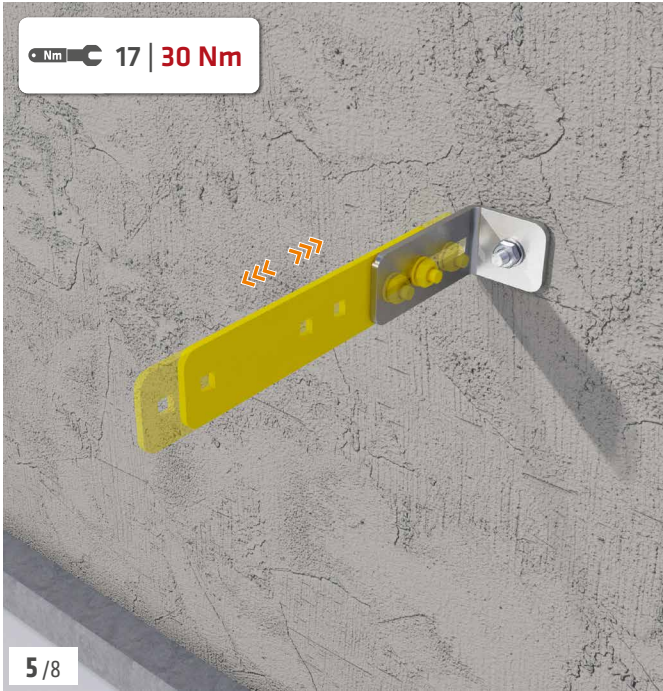

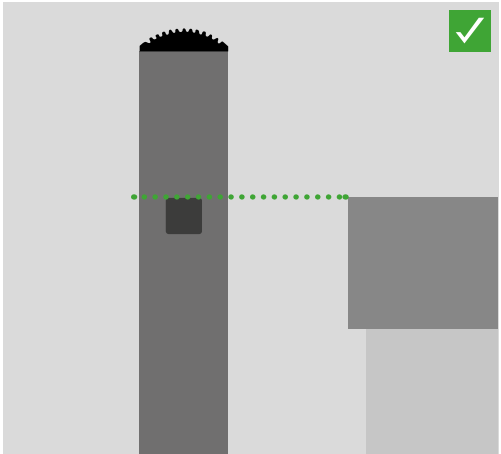
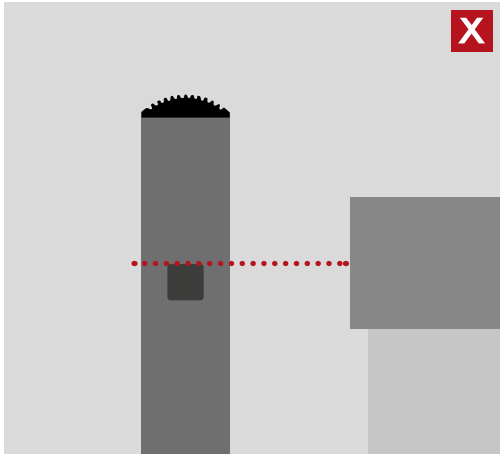

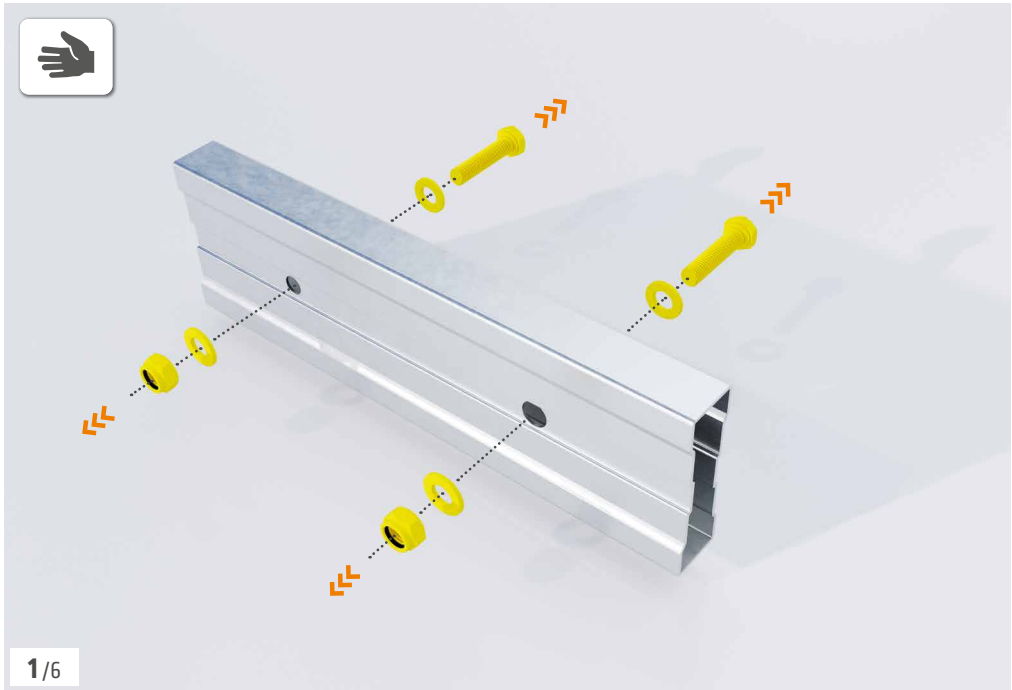



2/6



3/6

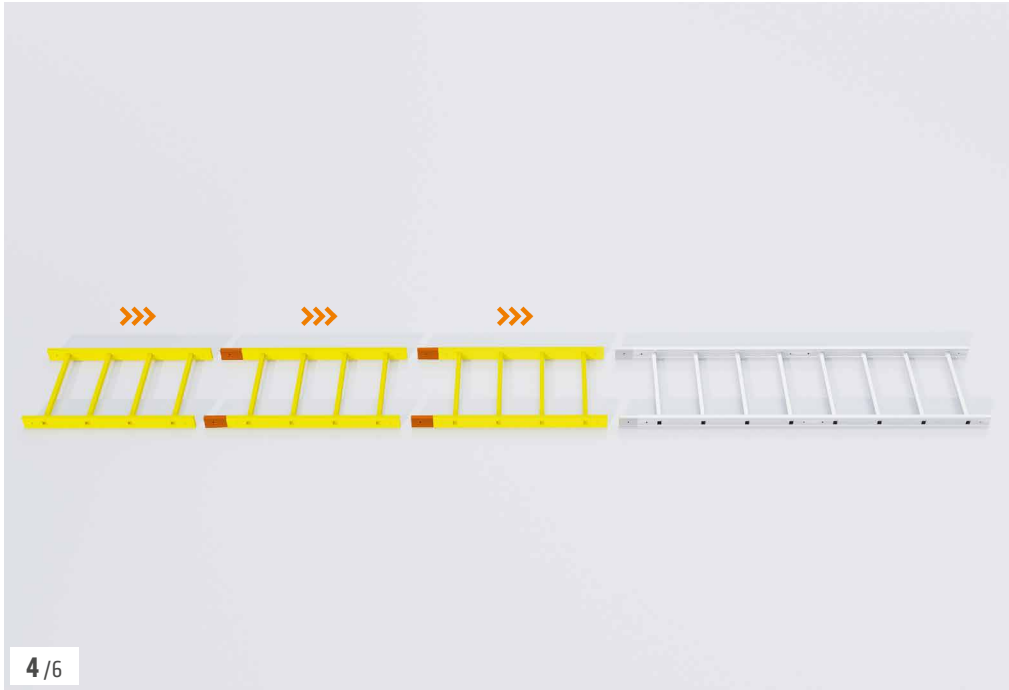

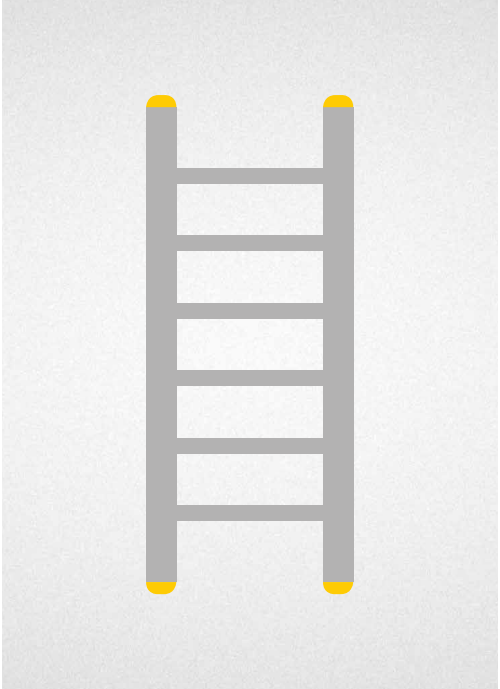

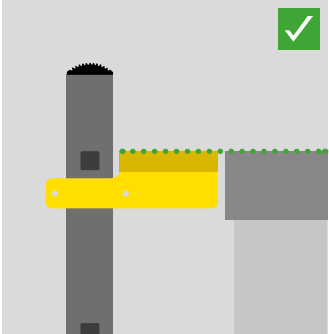
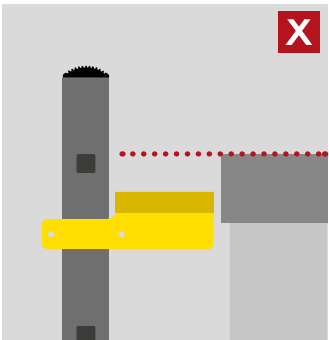

 Nm | 17 | 30 Nm

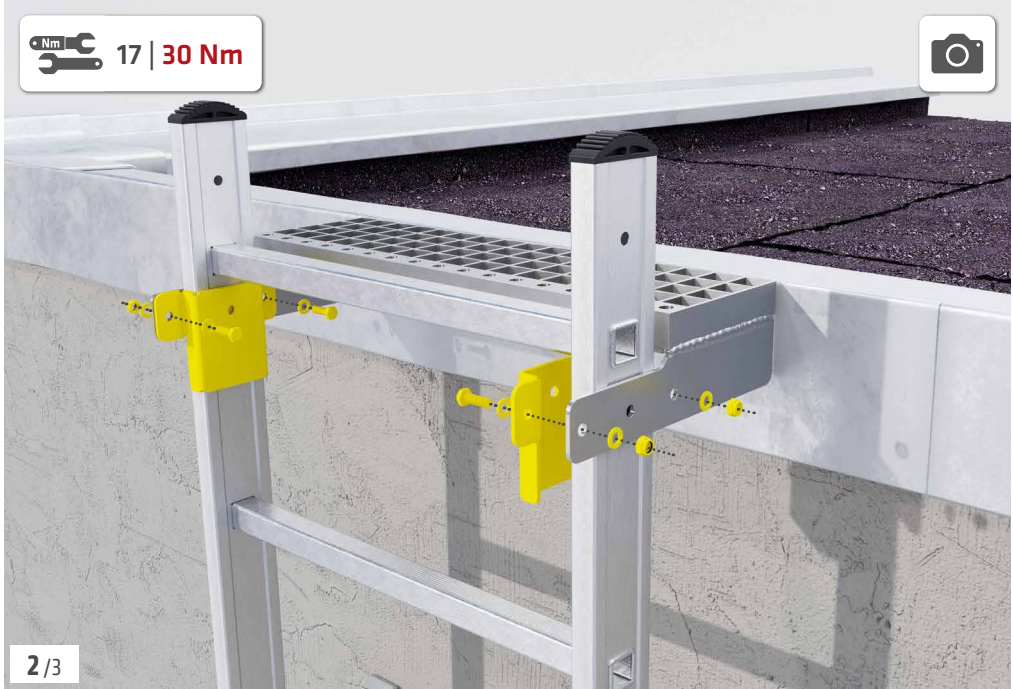

2/3



3/3

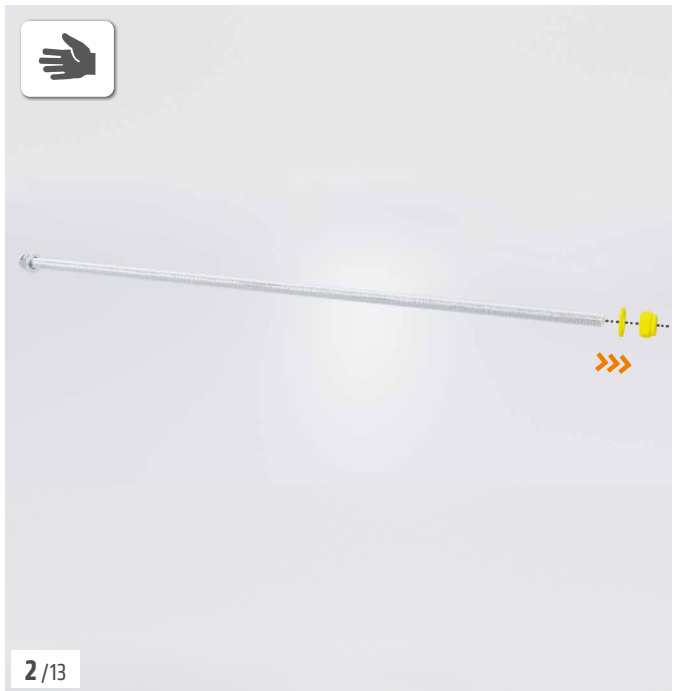
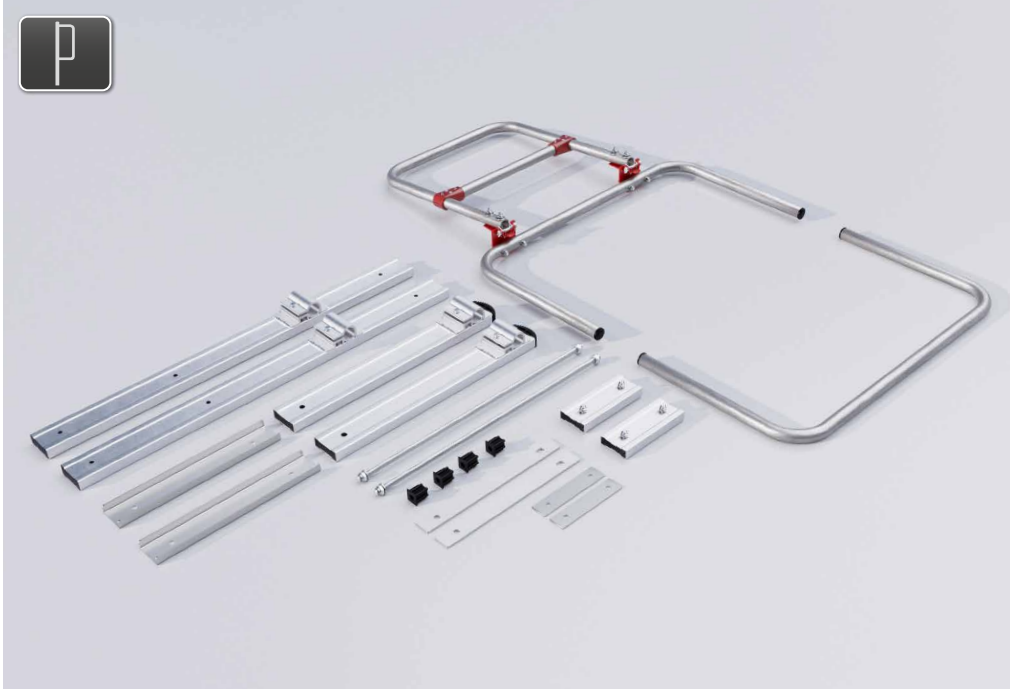

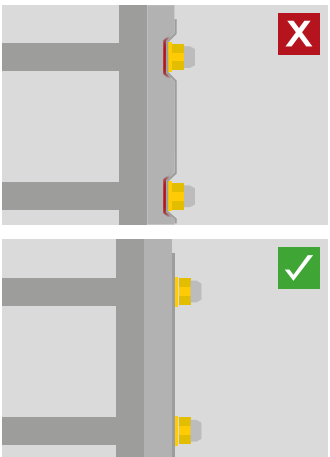
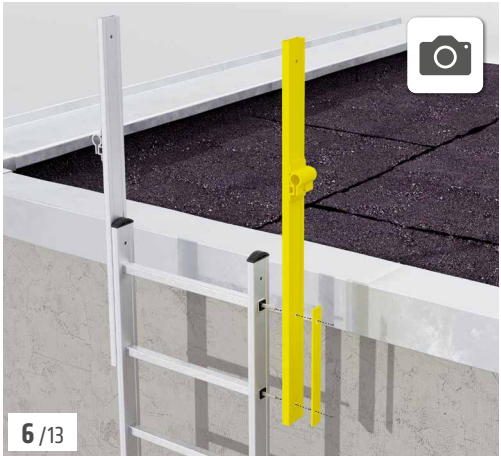
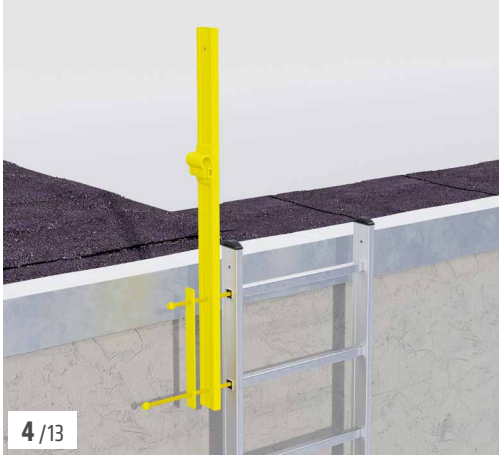

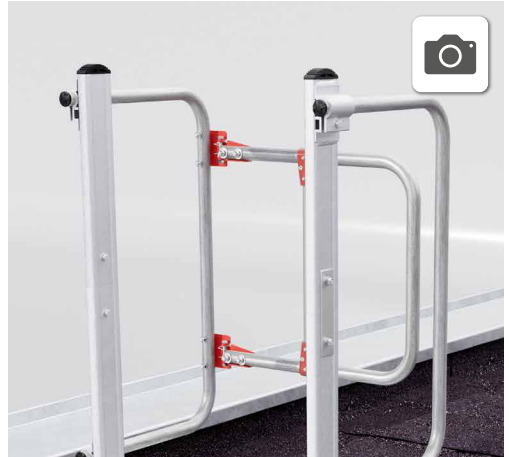
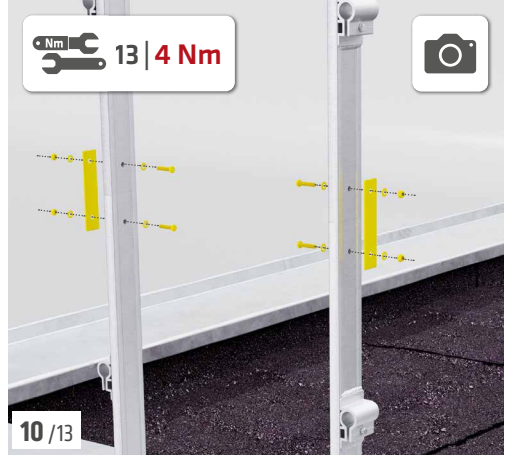
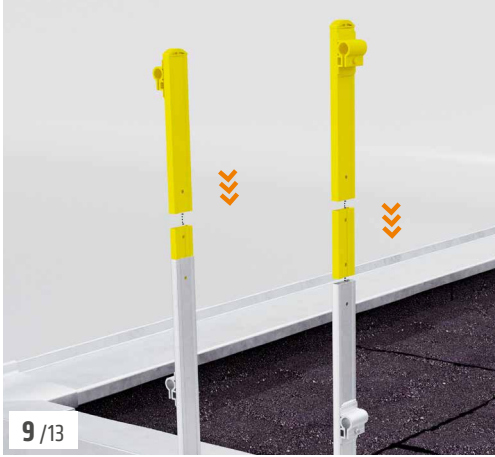

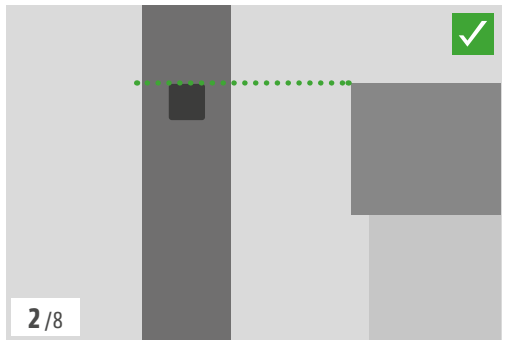
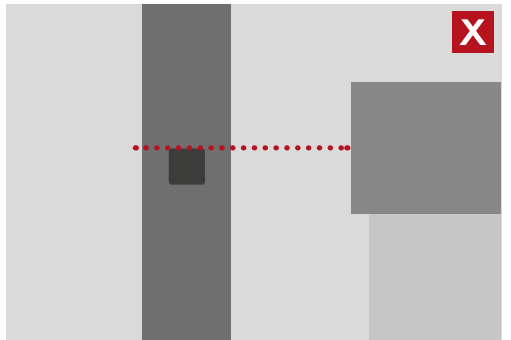
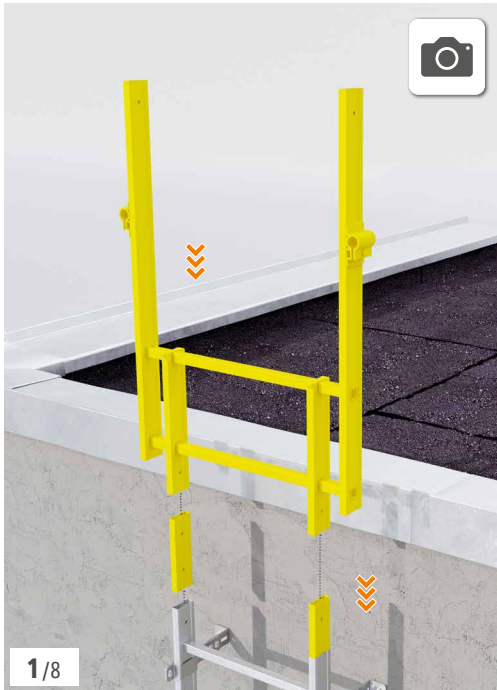
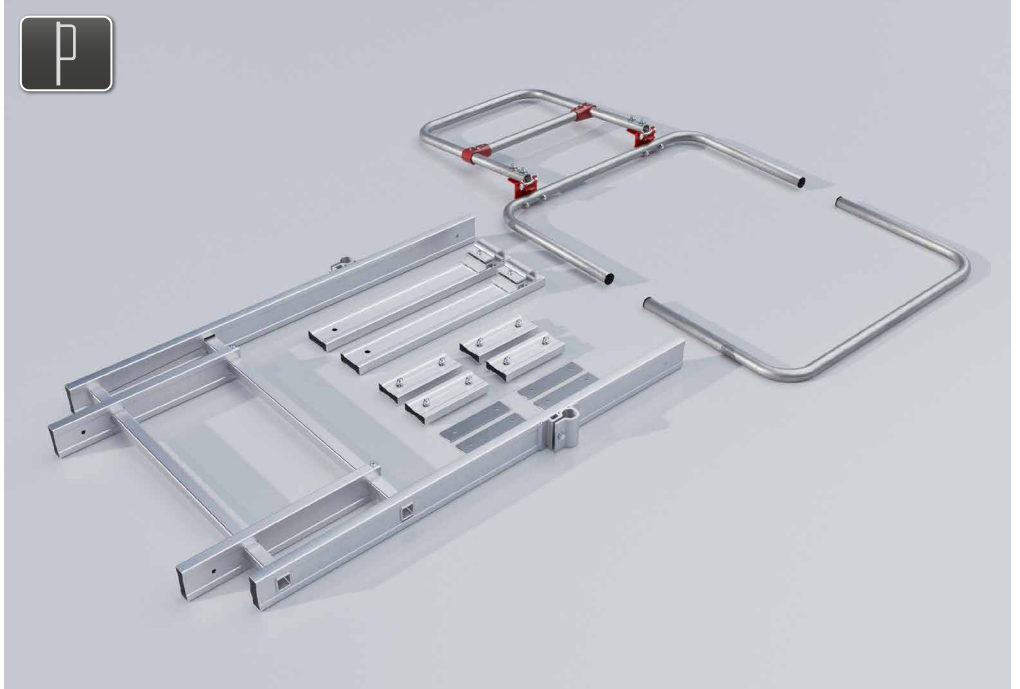

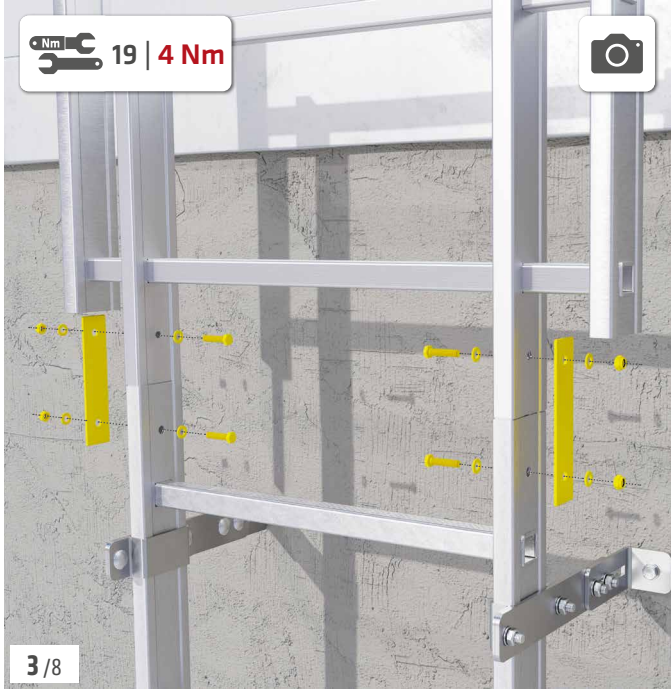



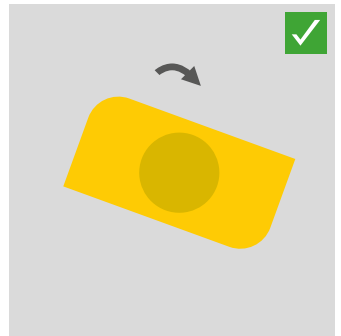
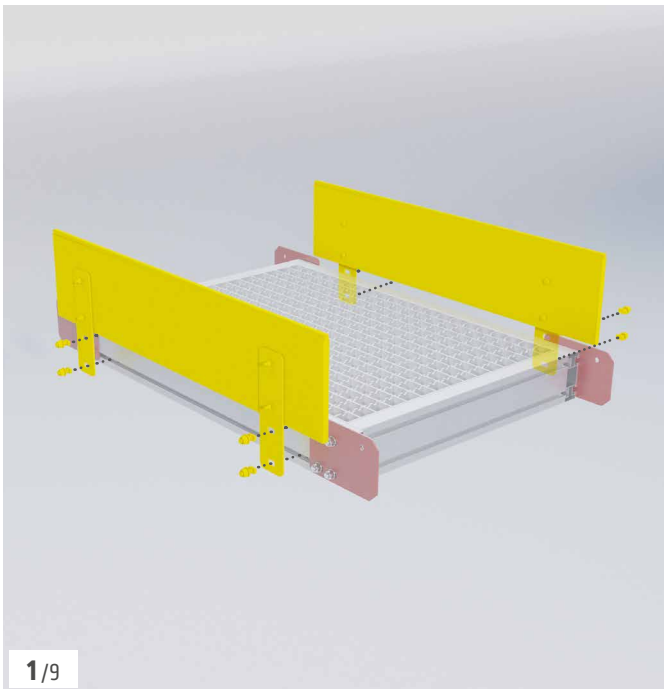
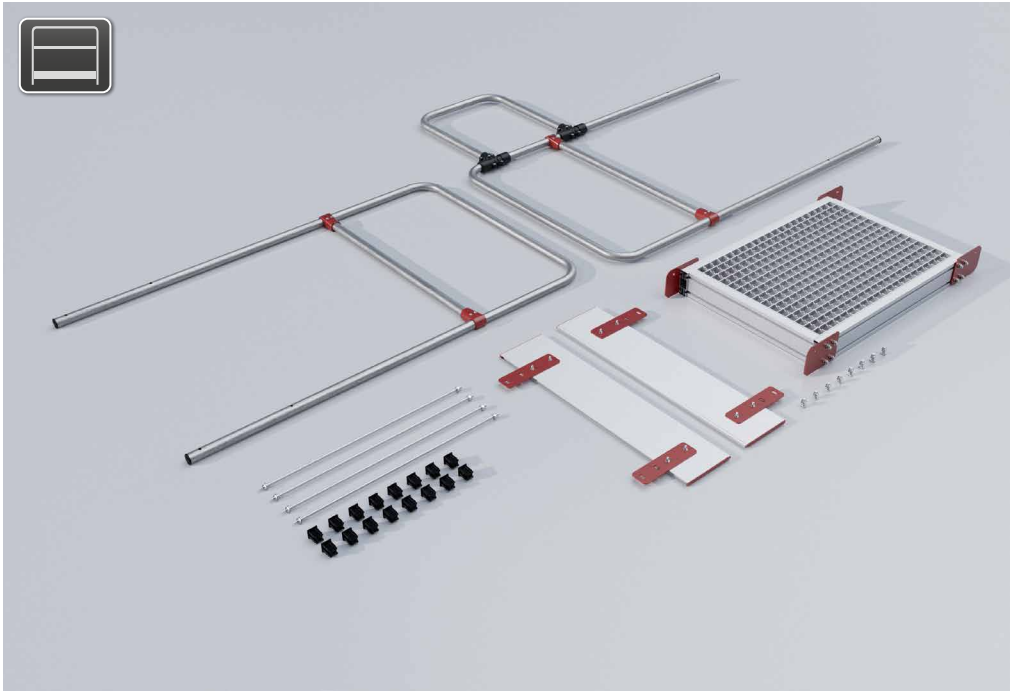

• Nm  13 | 16 Nm

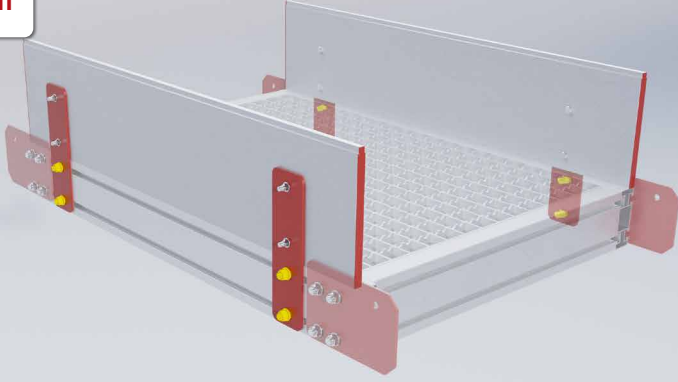

2/9

8x

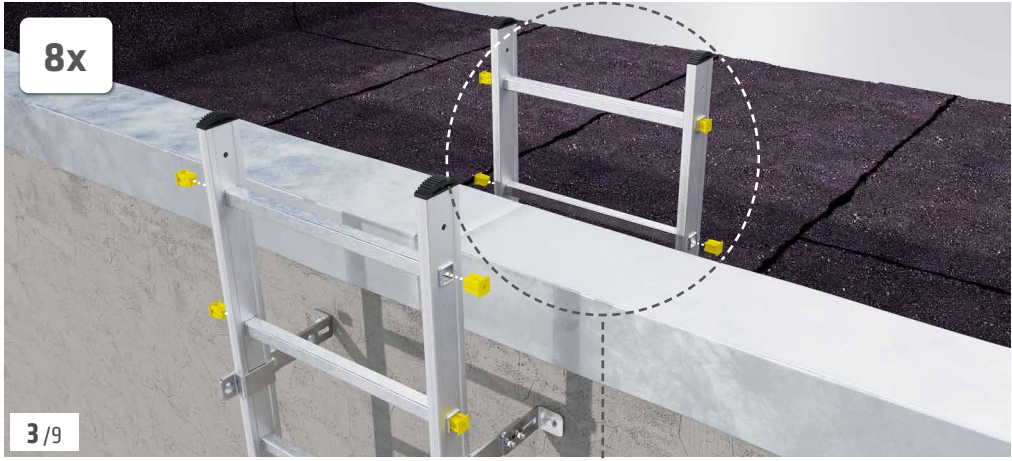

3/9

min.  
3x

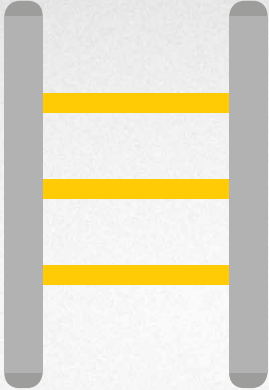



4 / 9

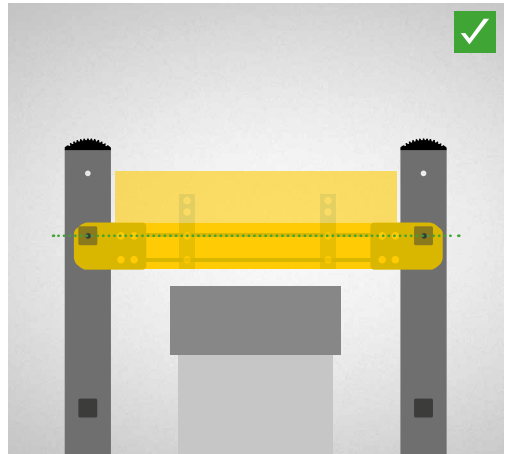
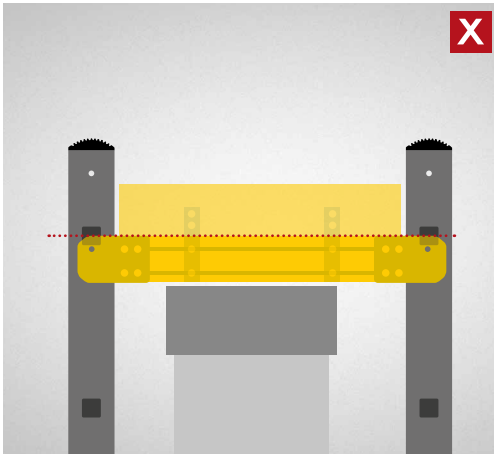



5 / 9

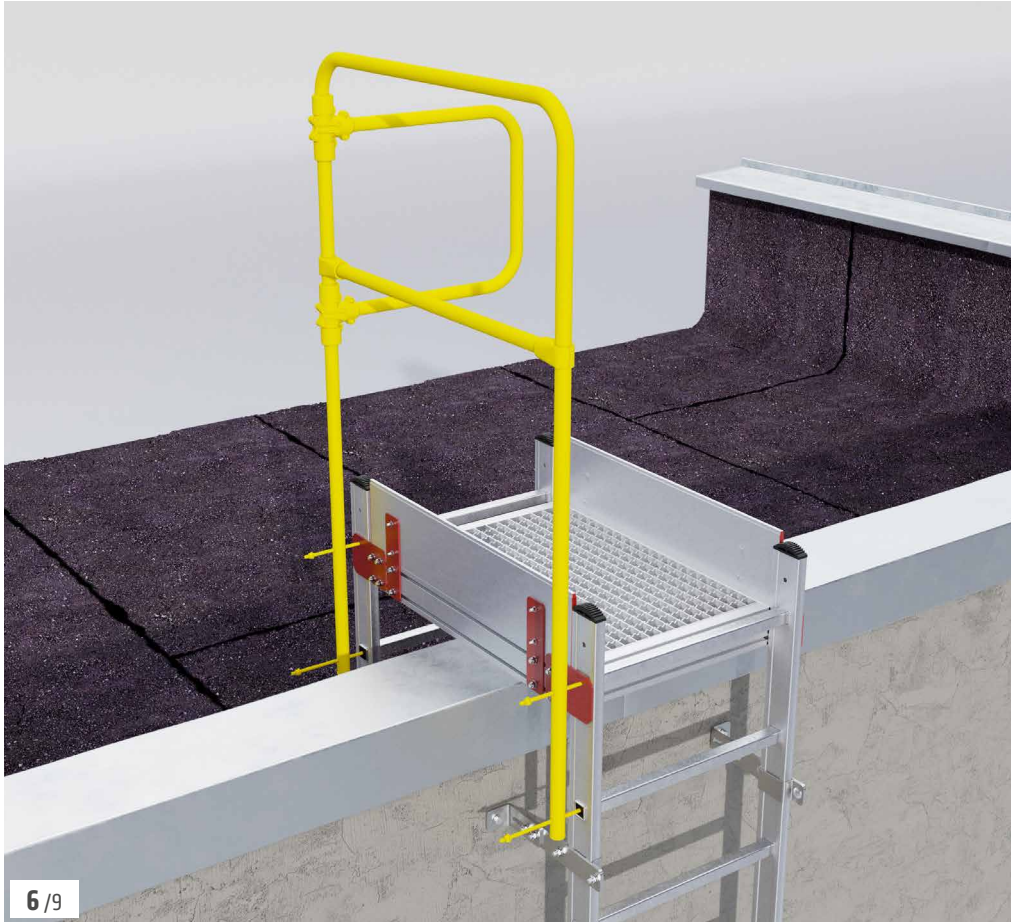

6 / 9





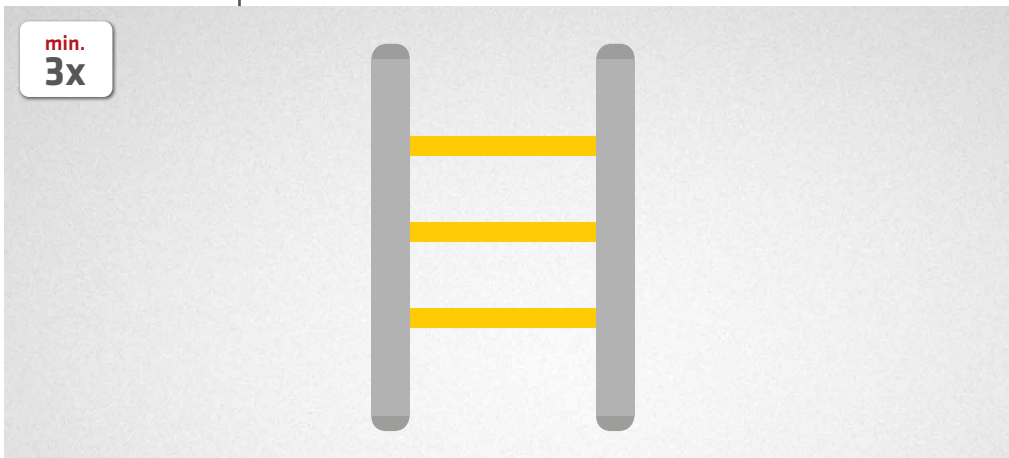
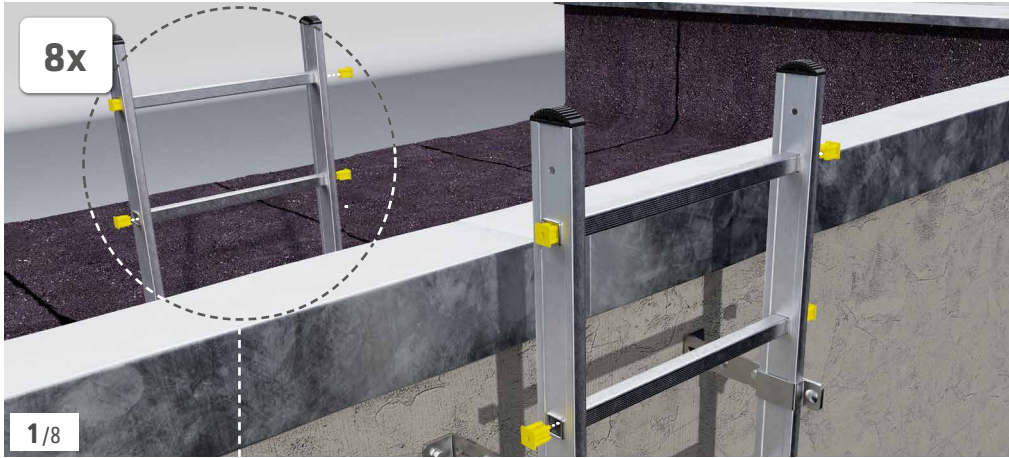
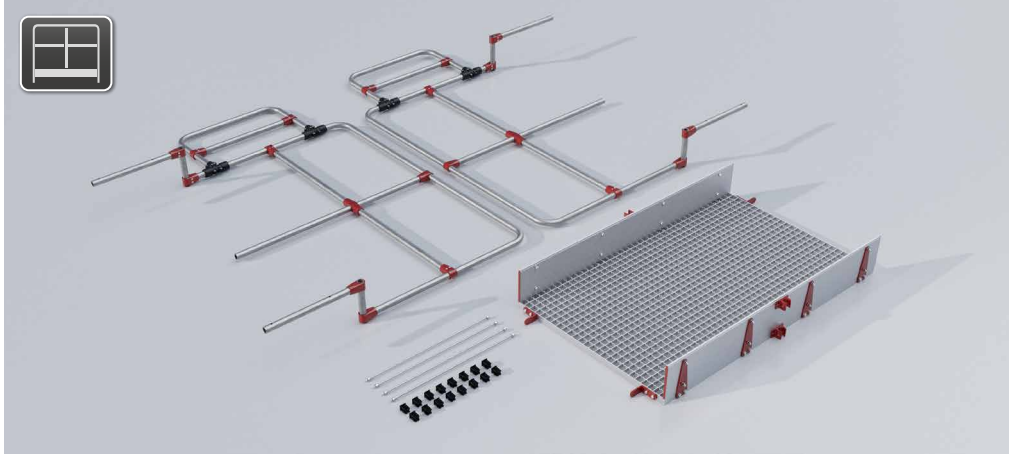

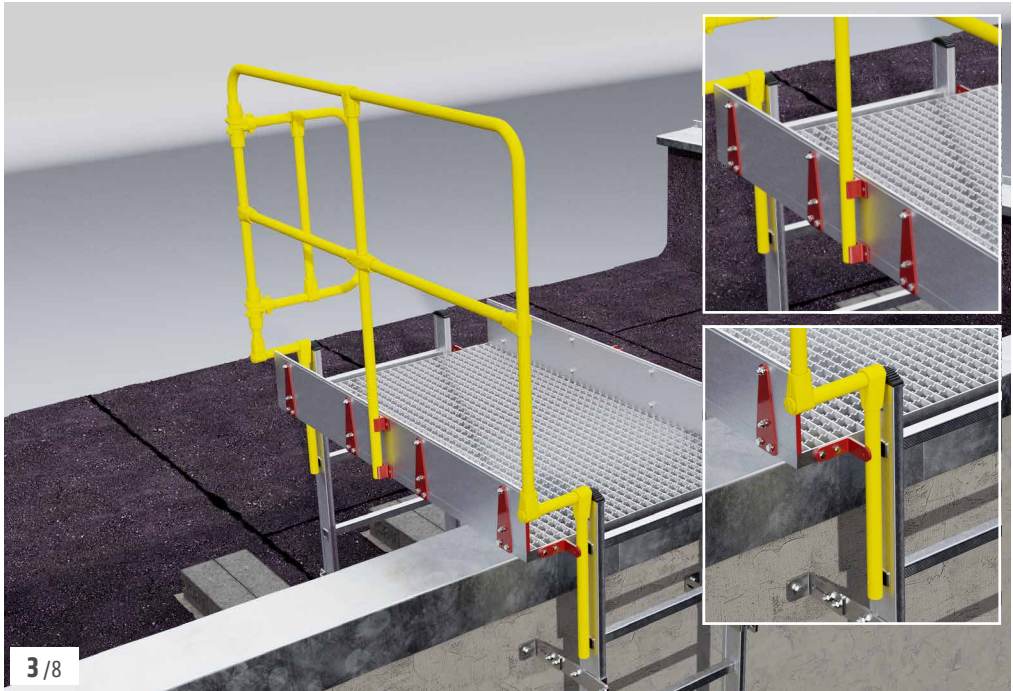
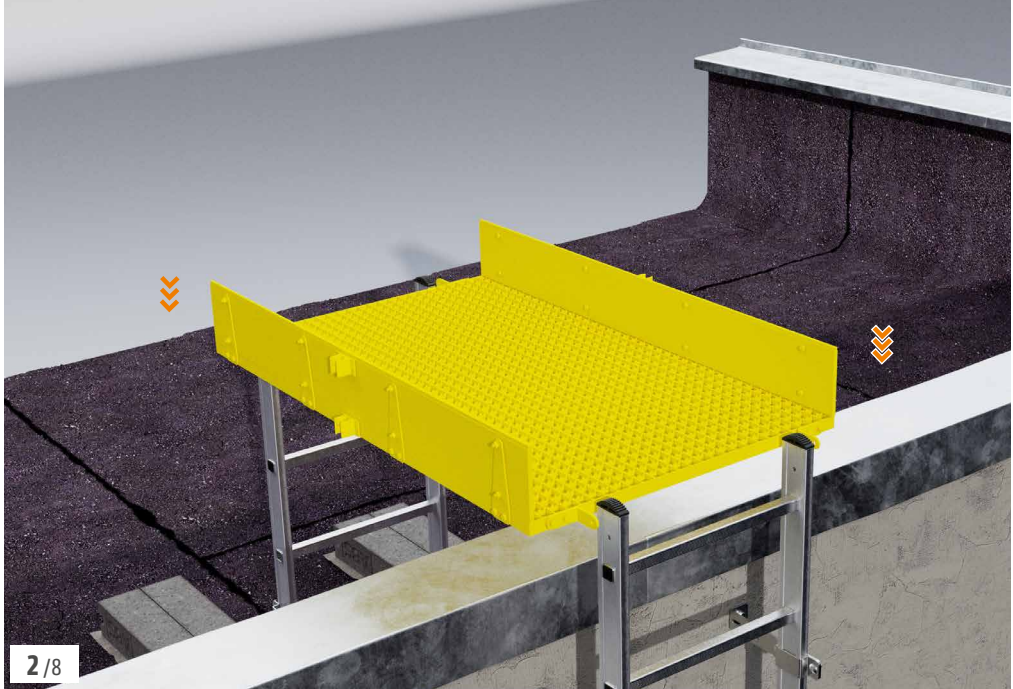



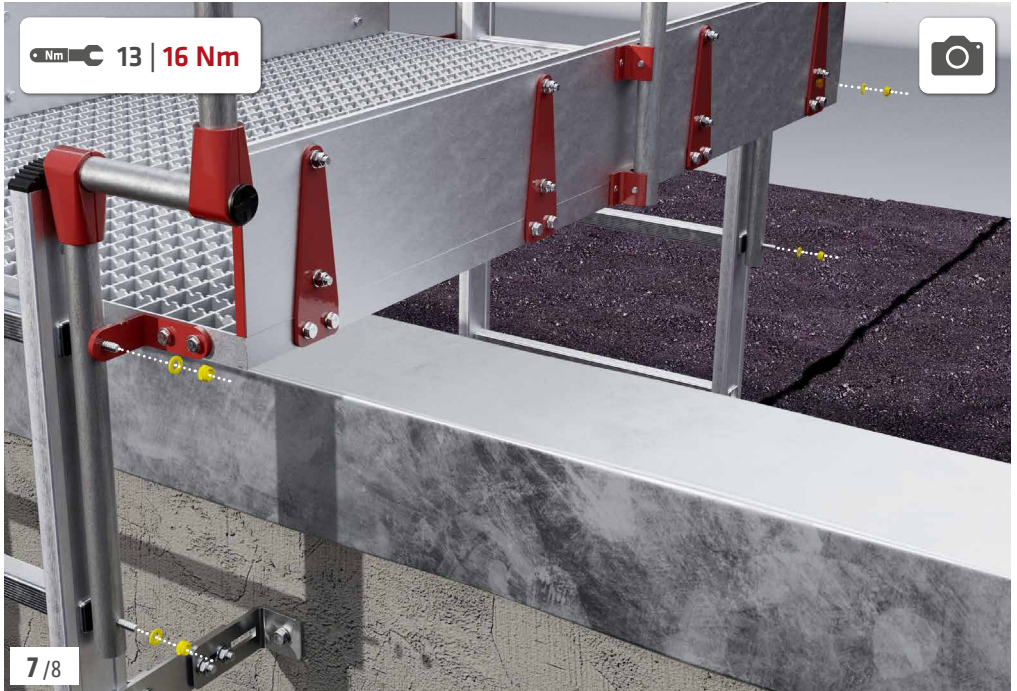



MoA 251  
ABS SafetyHike®

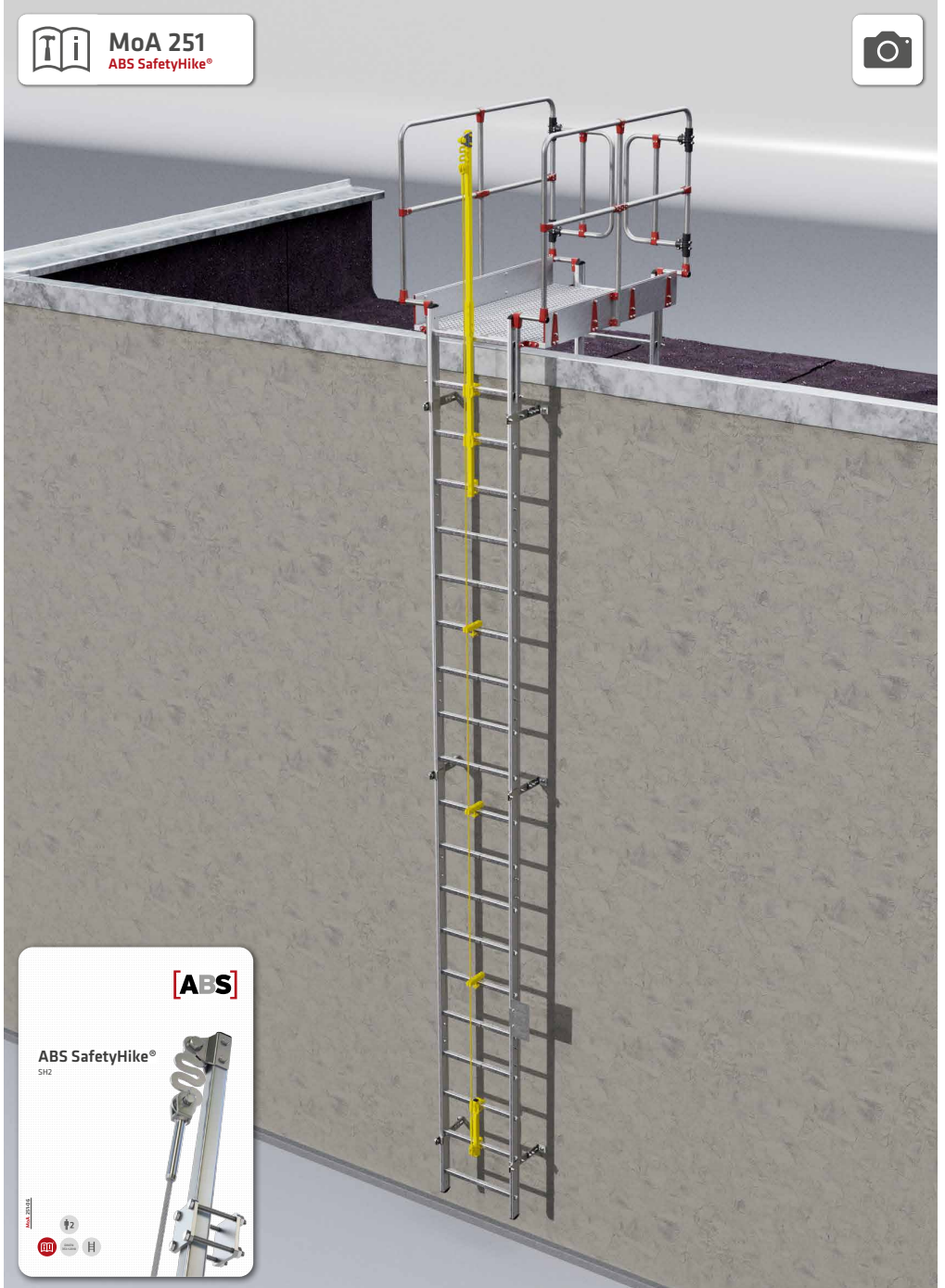

[ABS]

ABS SafetyHike®  
SH2



SL2-XXX



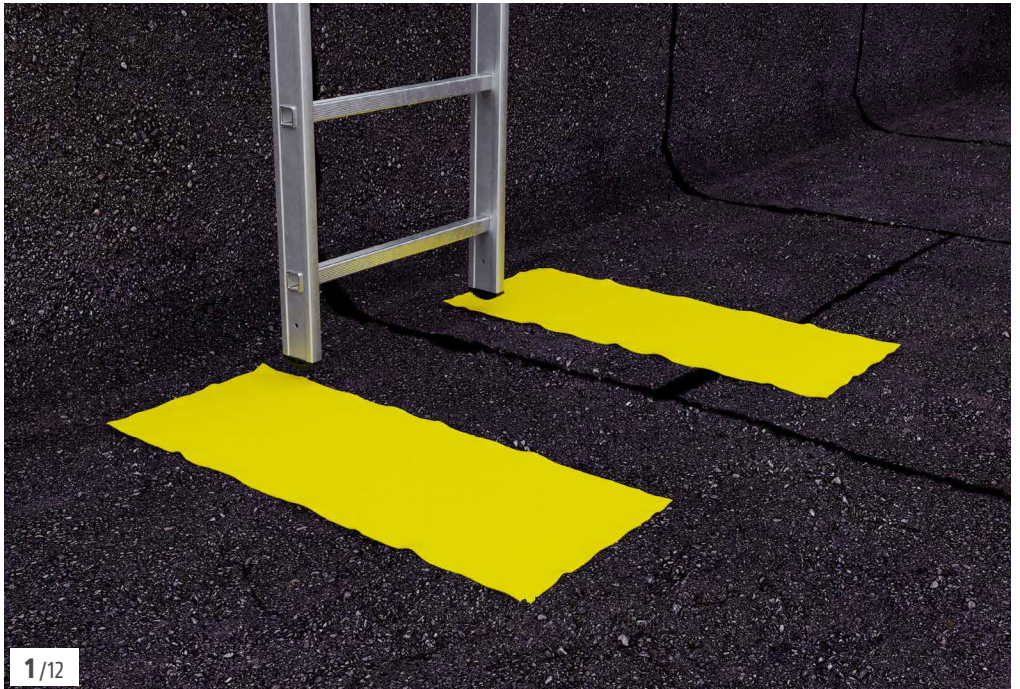
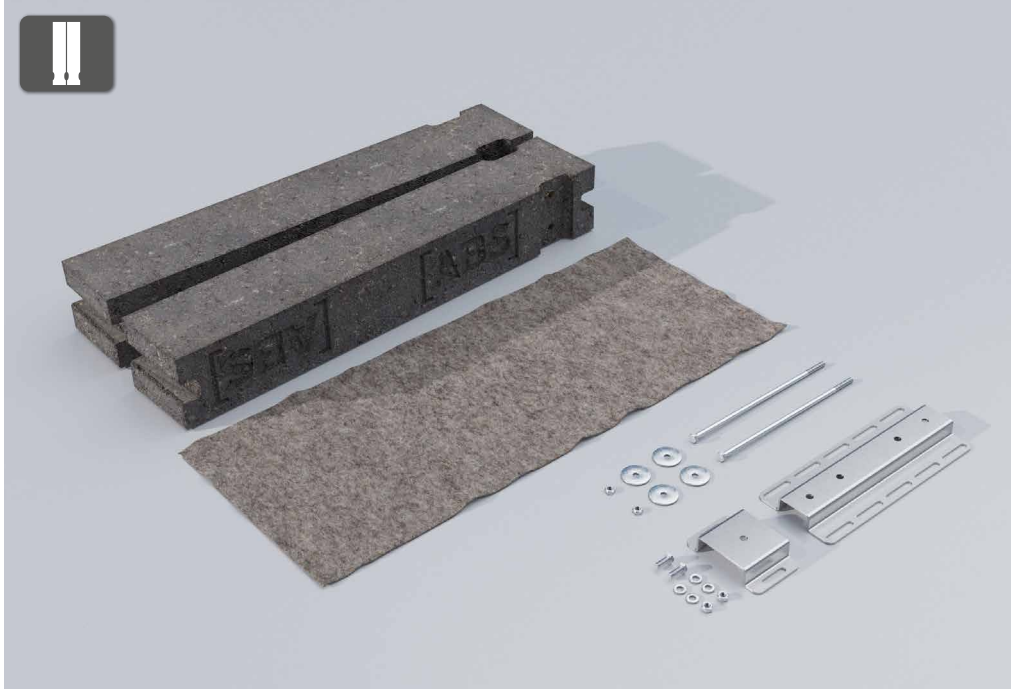

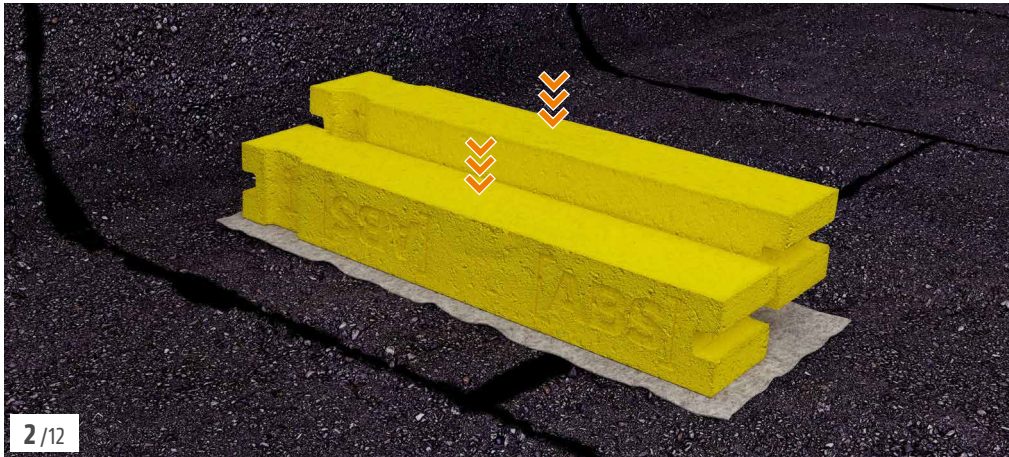

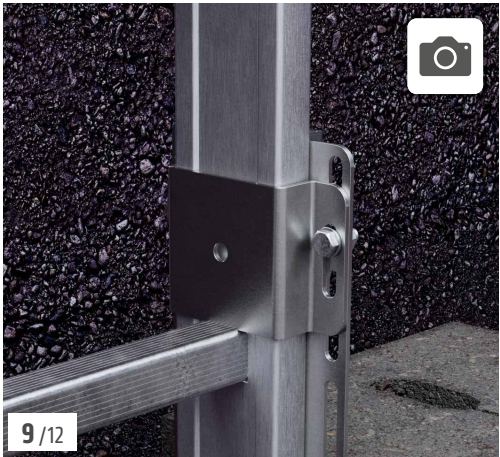
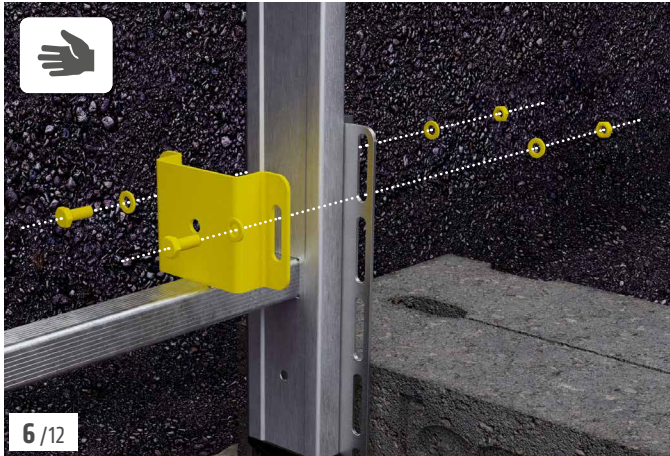

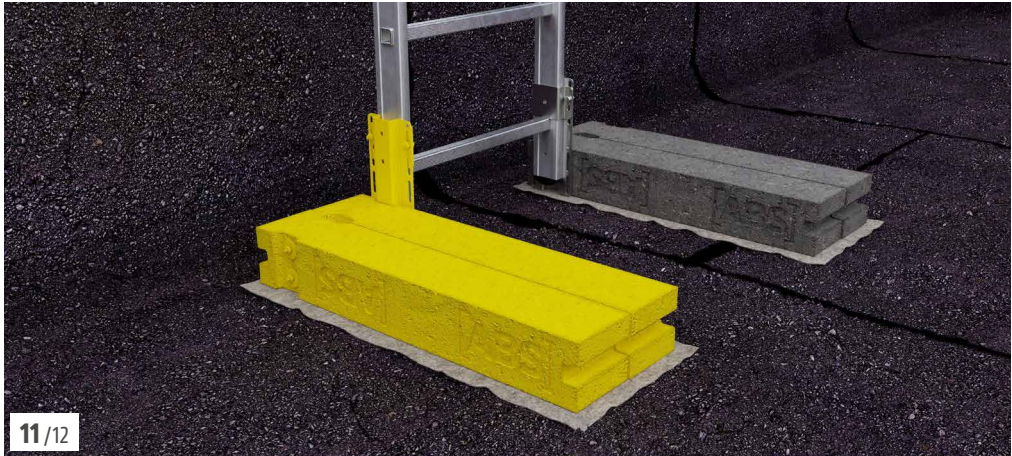

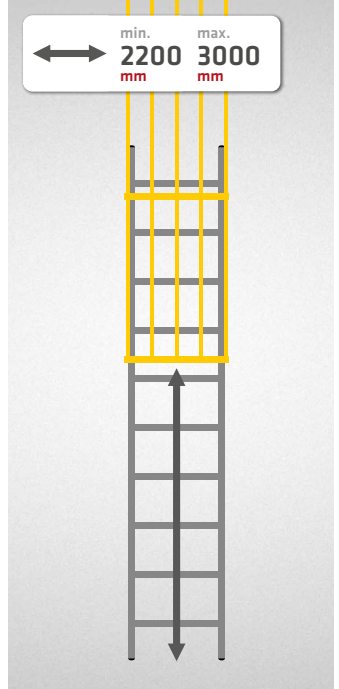

**VAR. 1**



**VAR. 2**





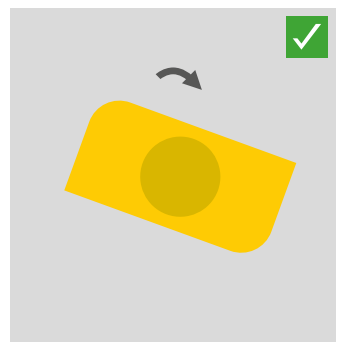
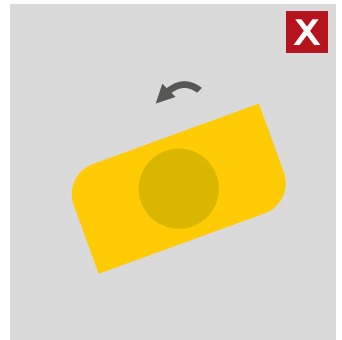
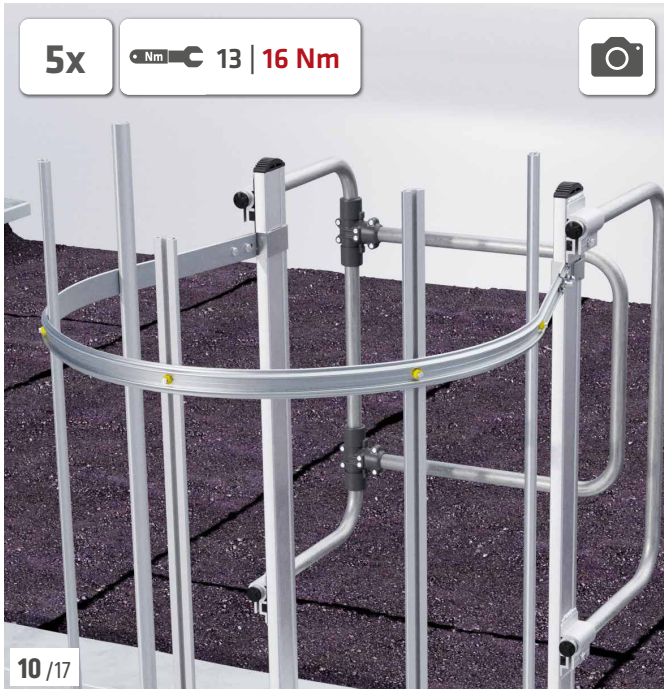



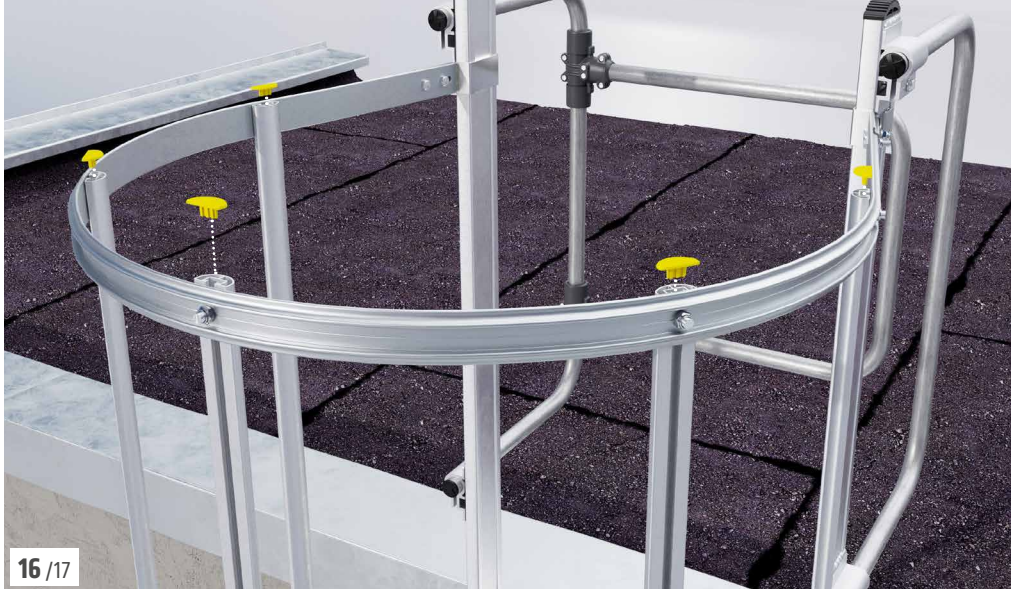



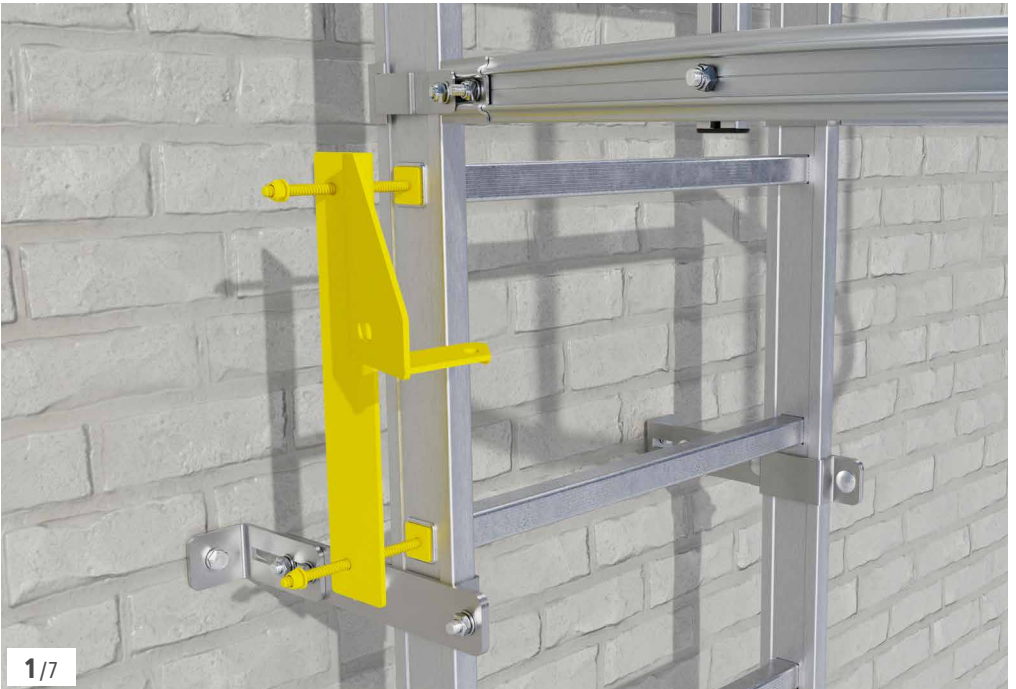
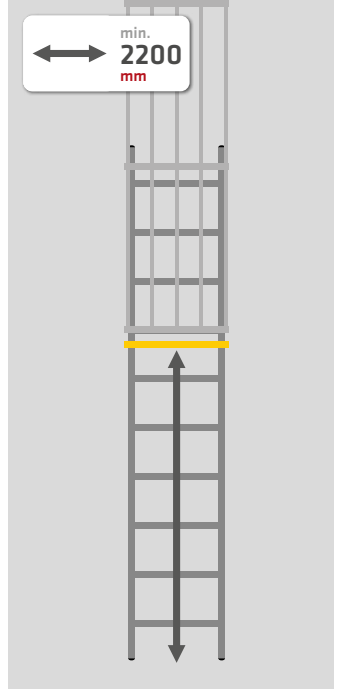







DIN 18799-3

6 / 7



7 / 7

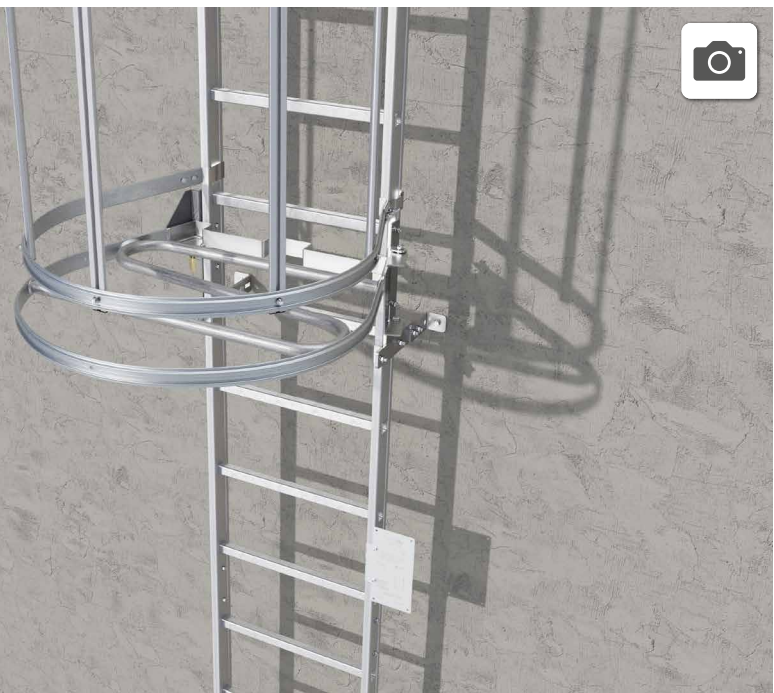

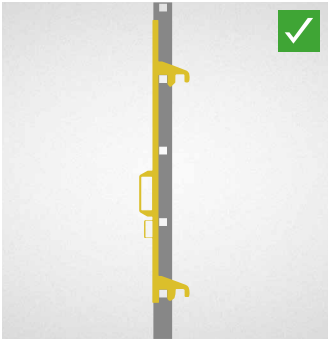
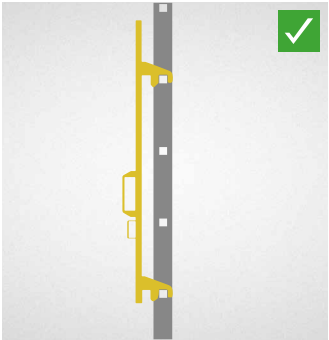
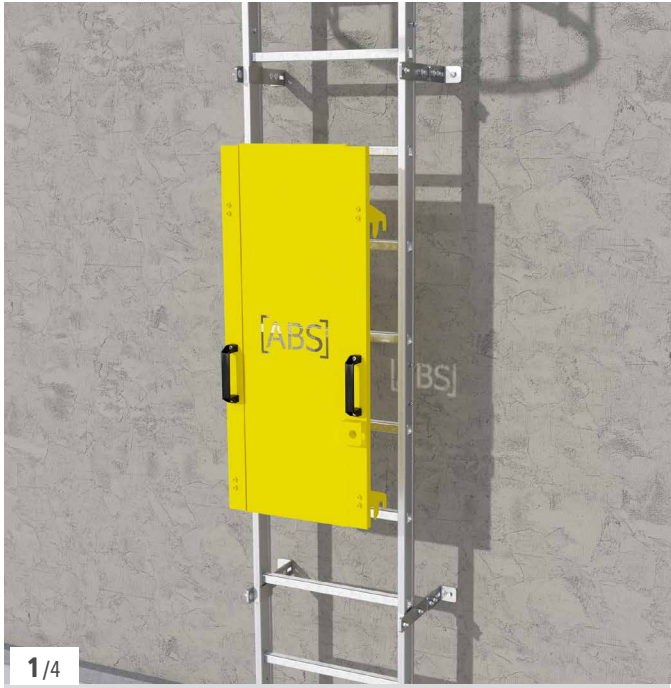

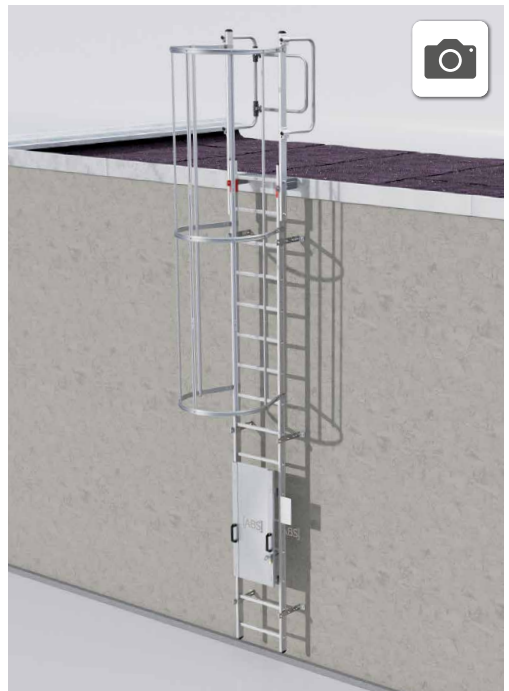

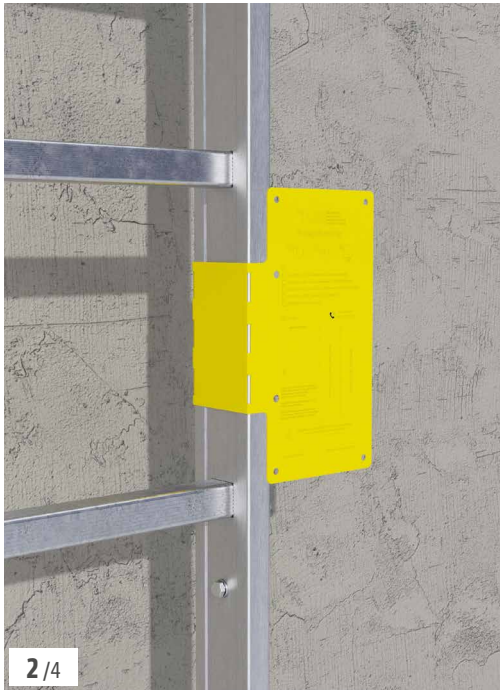
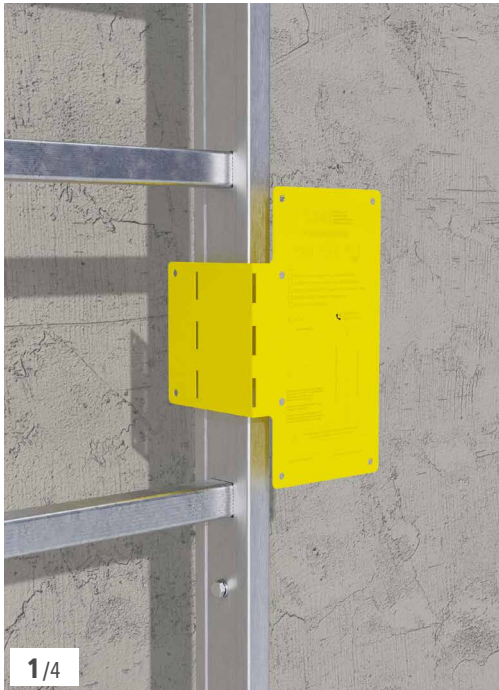

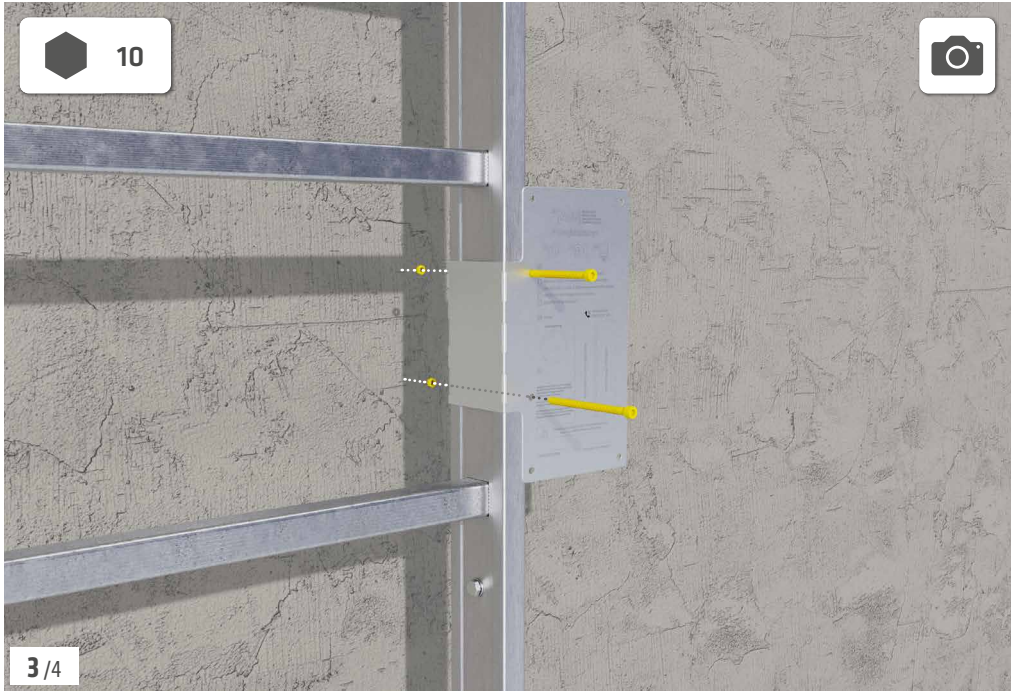

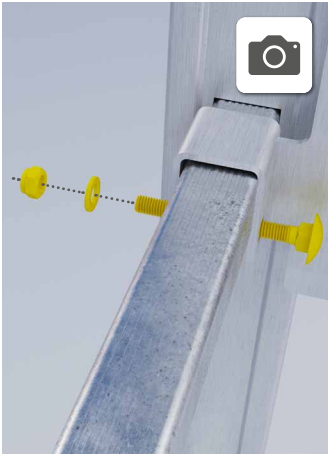

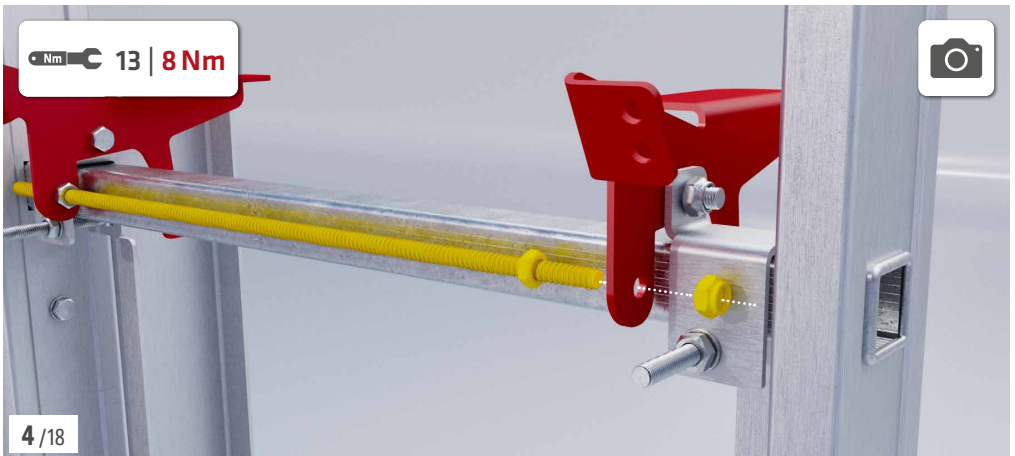
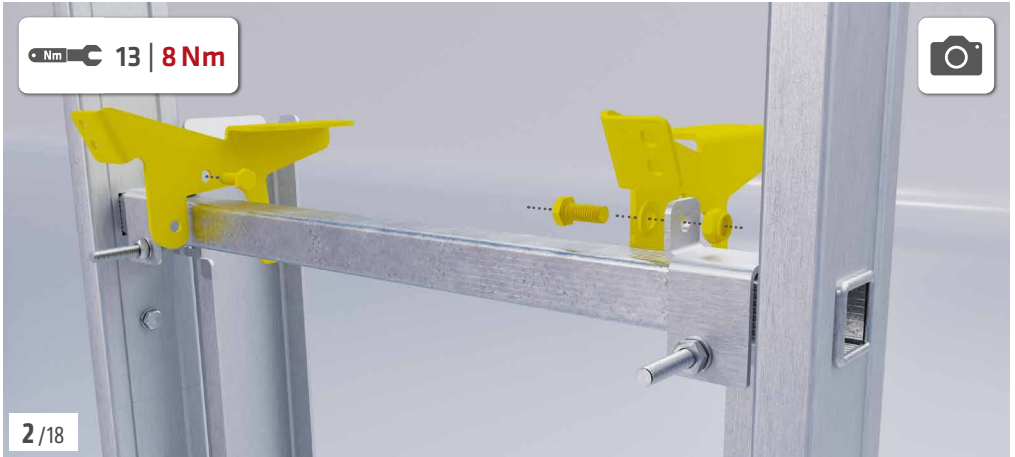

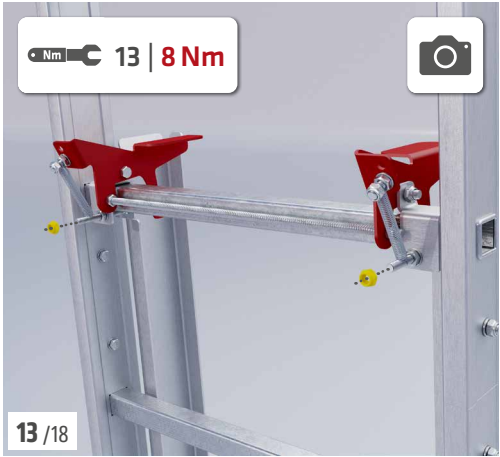
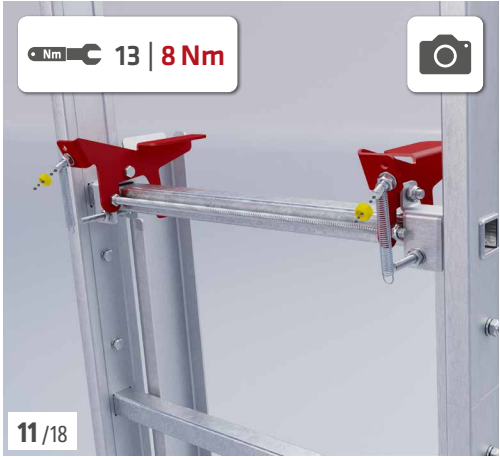
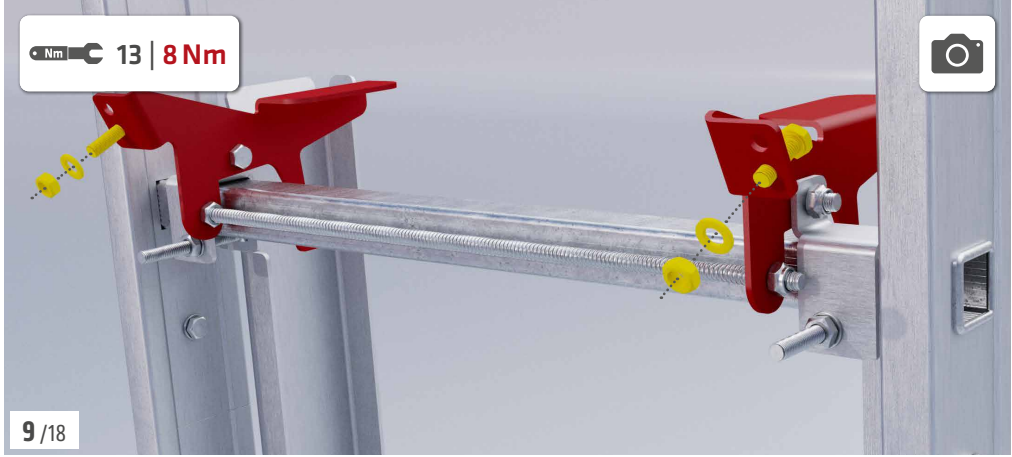



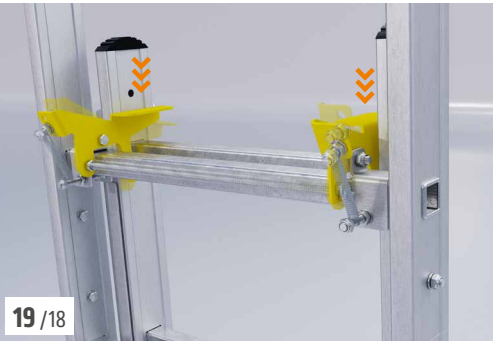
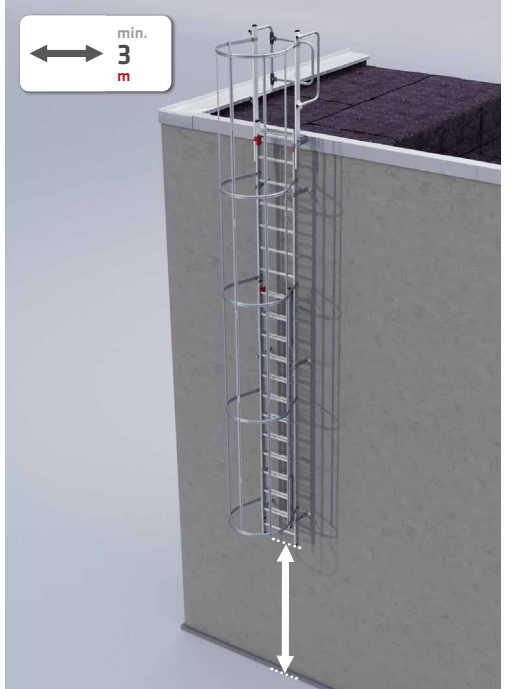
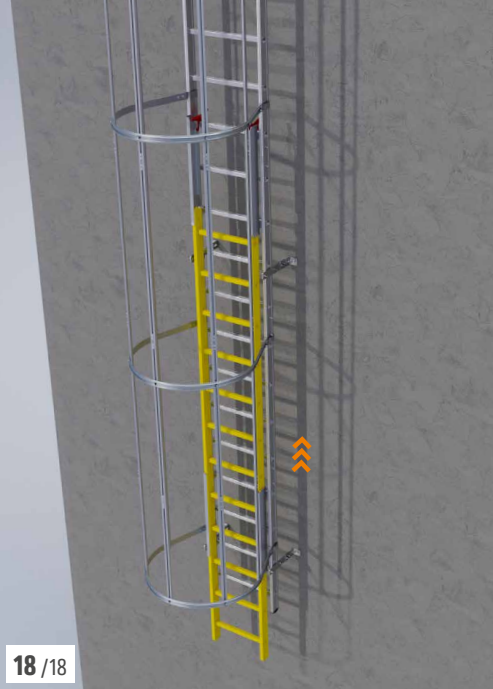

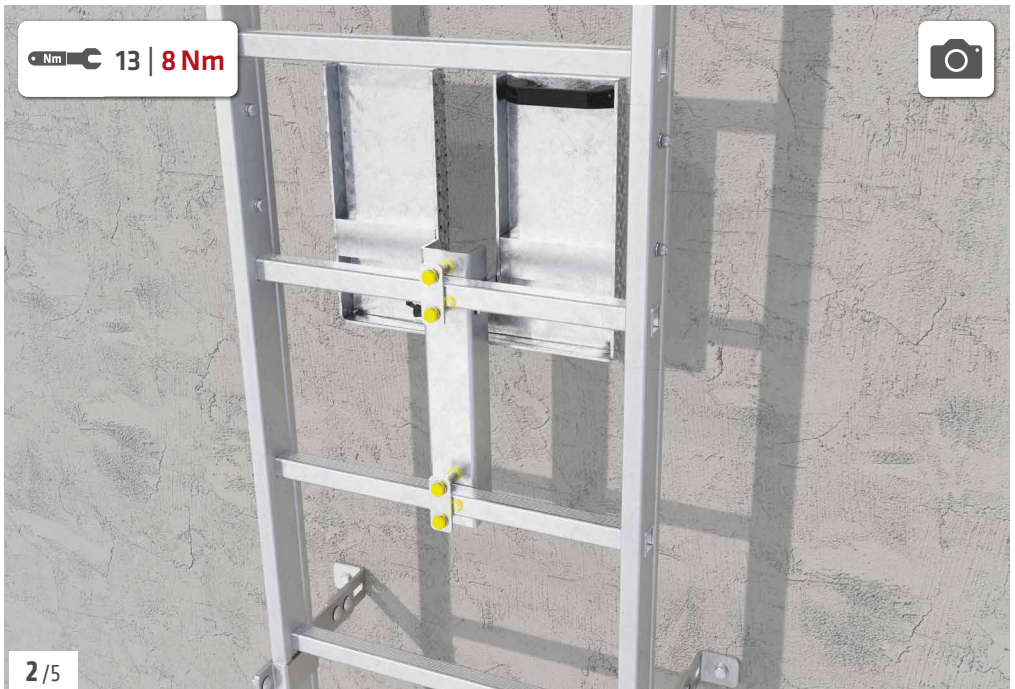
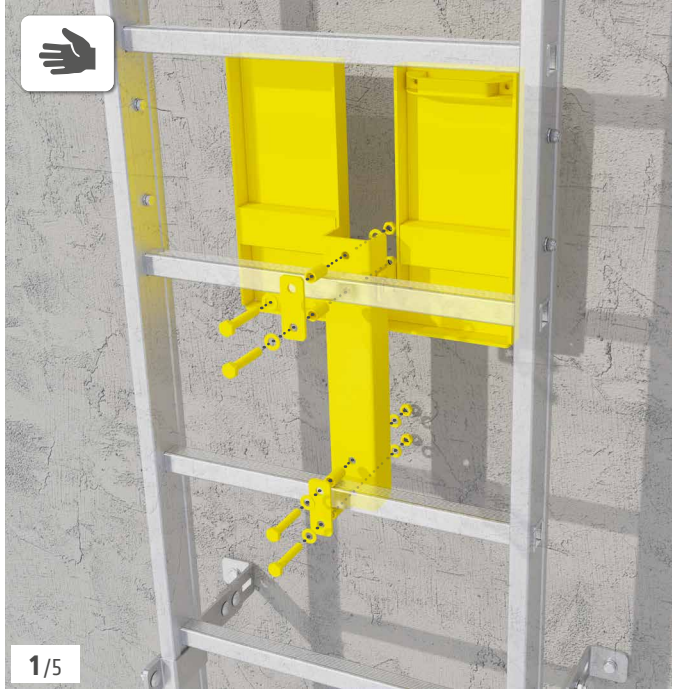
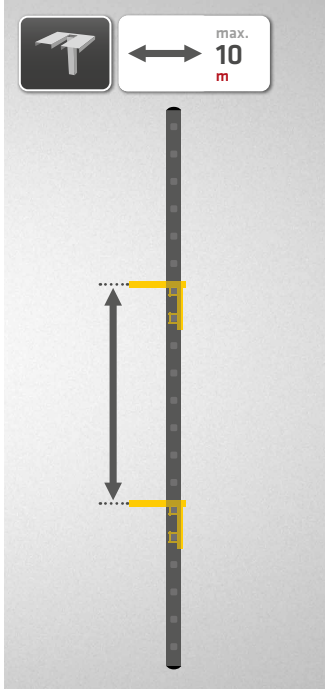

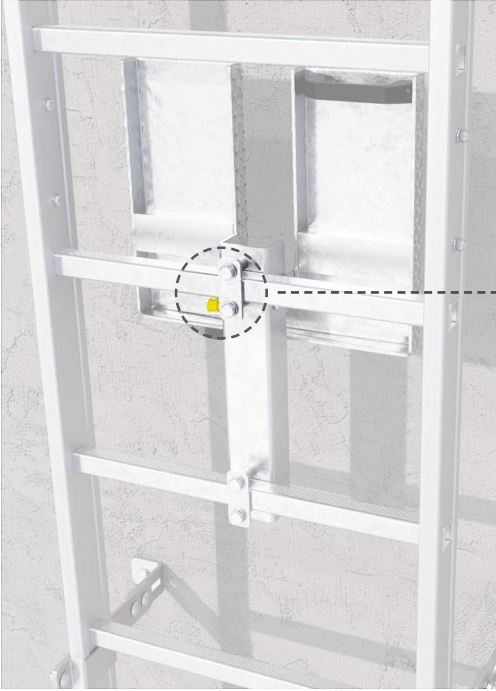

3/5



5/5

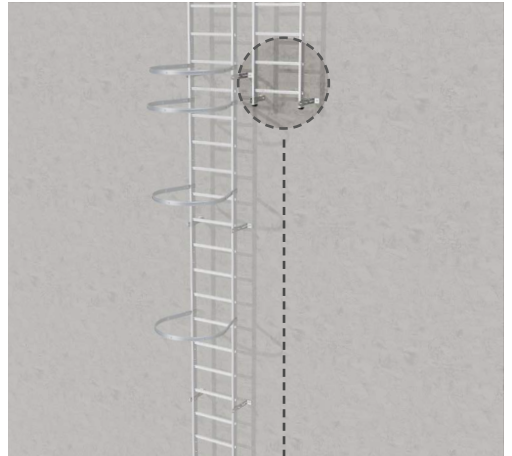
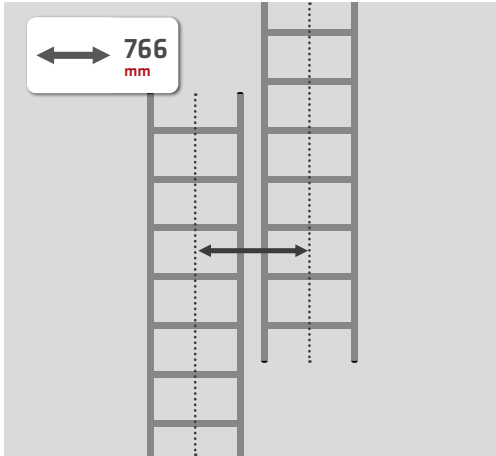
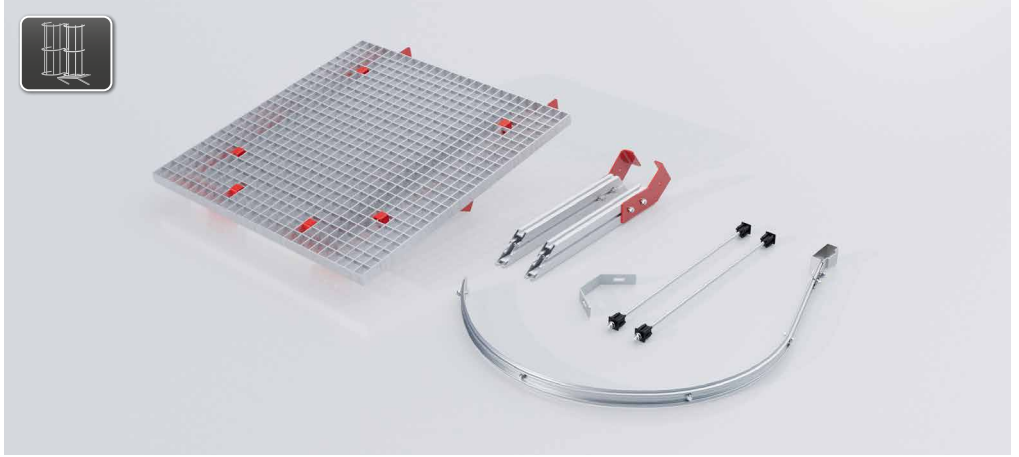

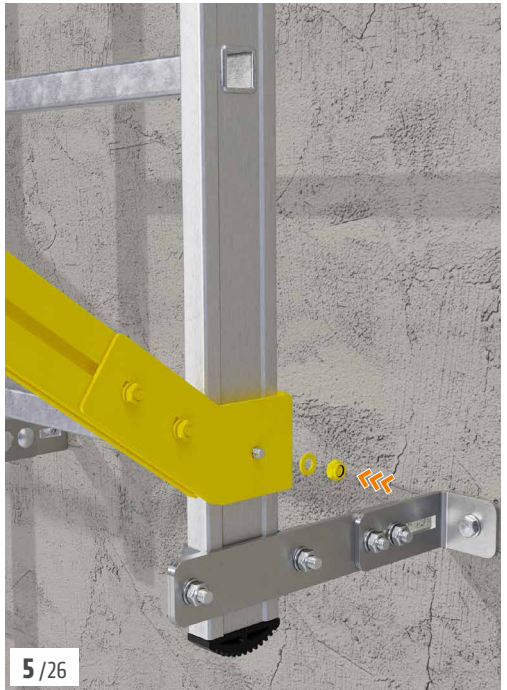
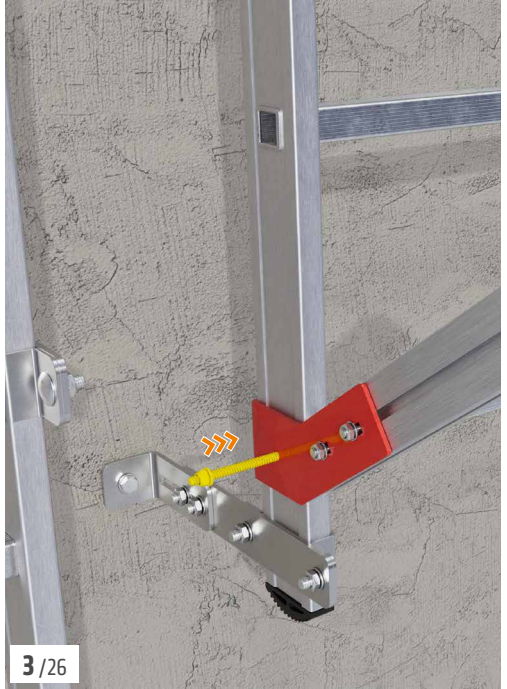
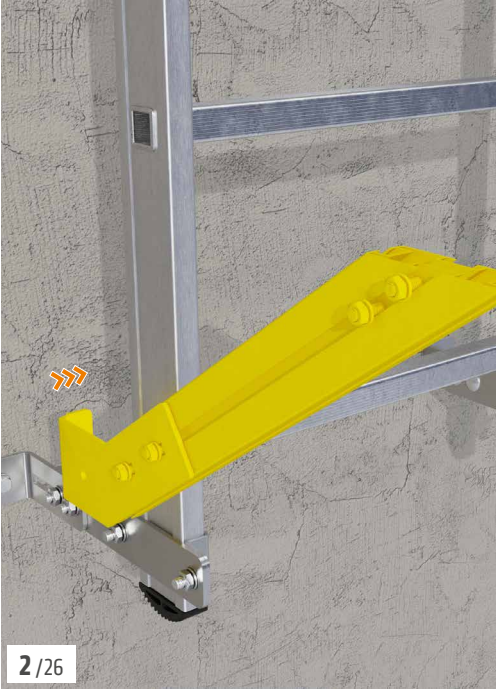

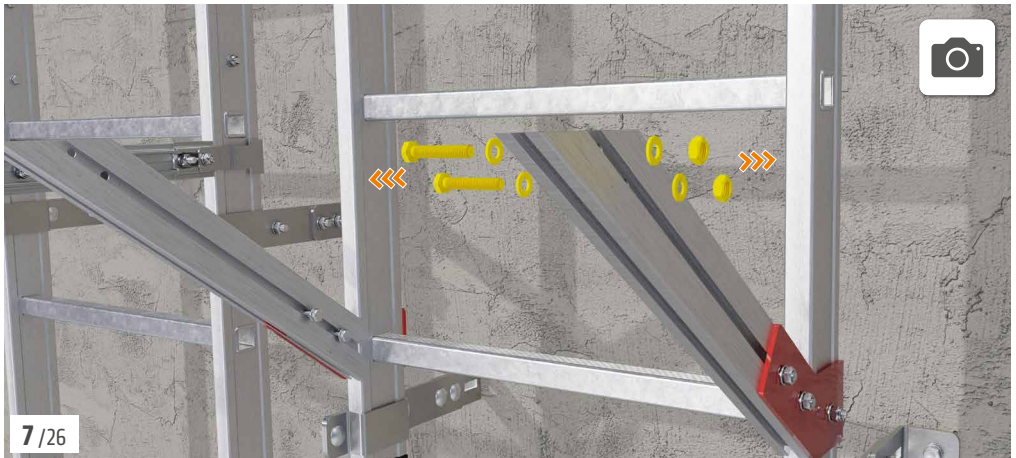
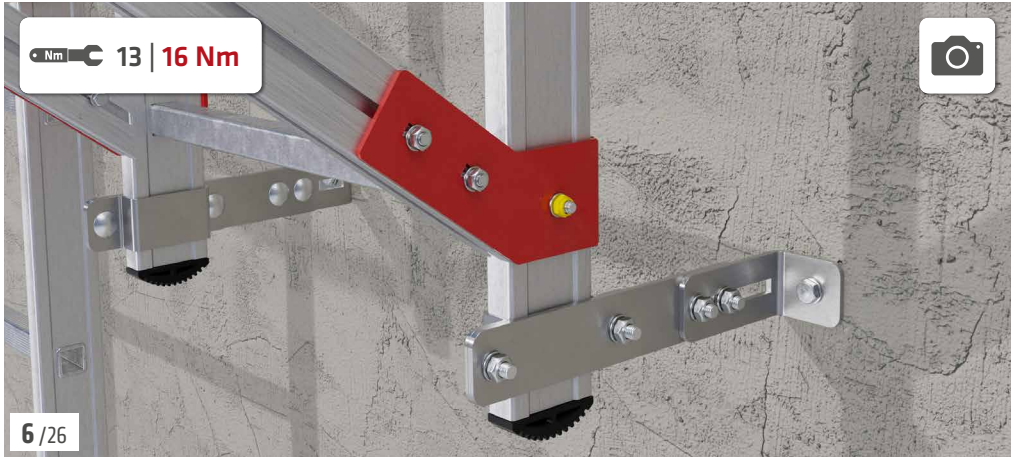

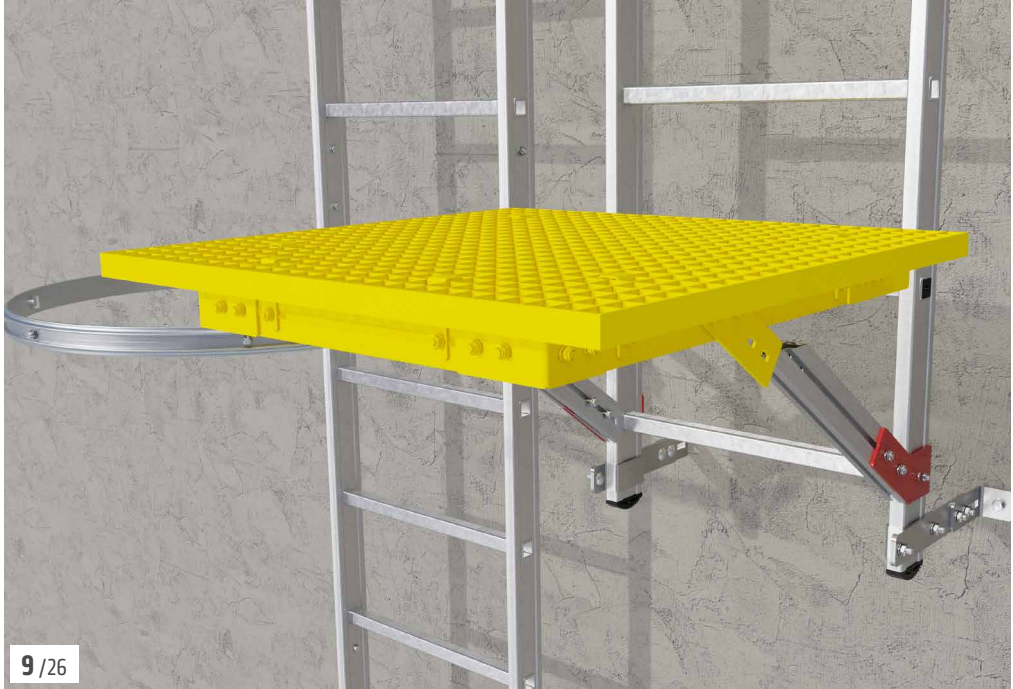

9 / 26

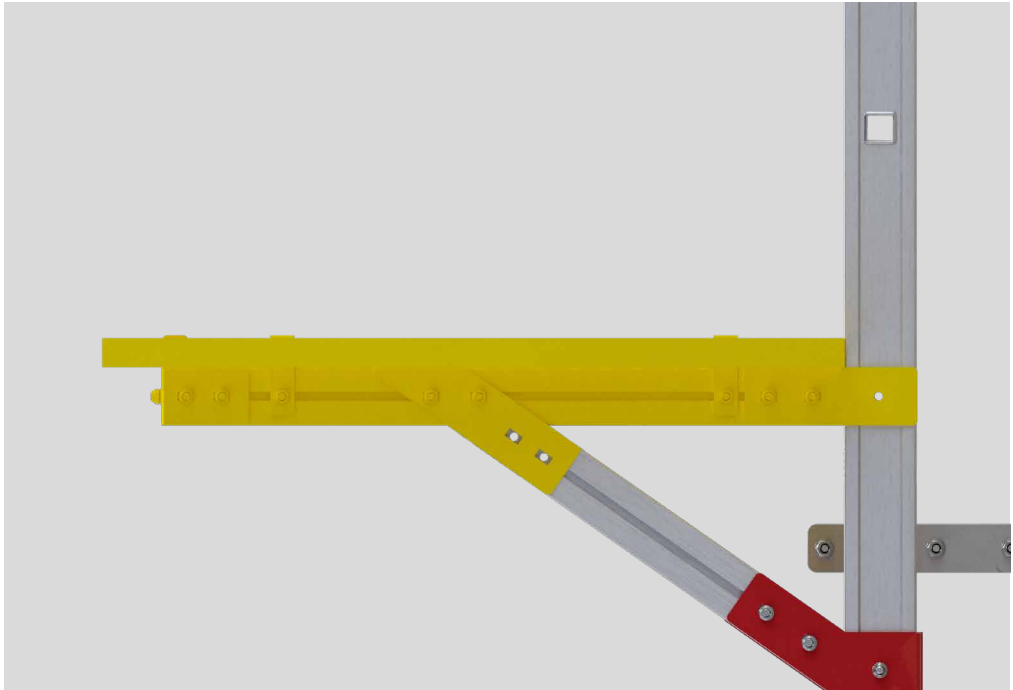

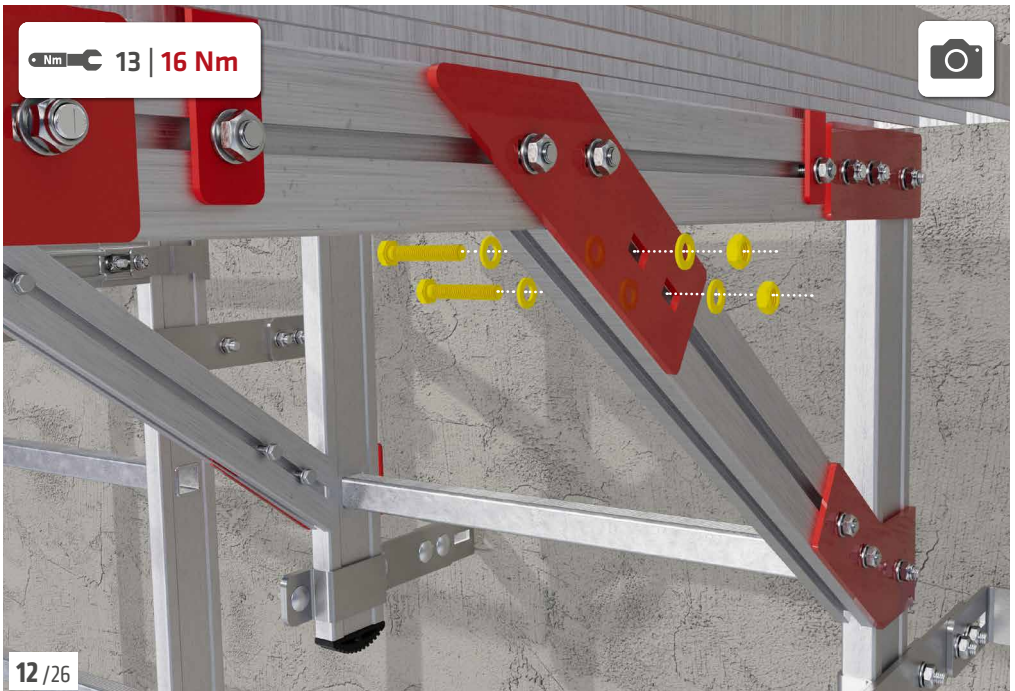
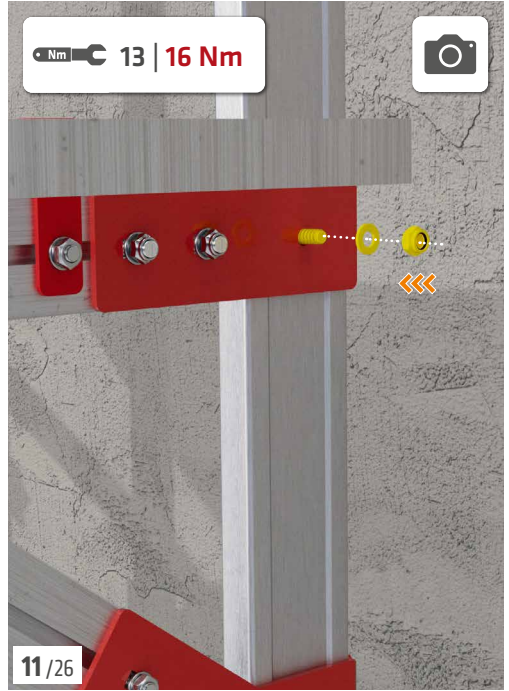

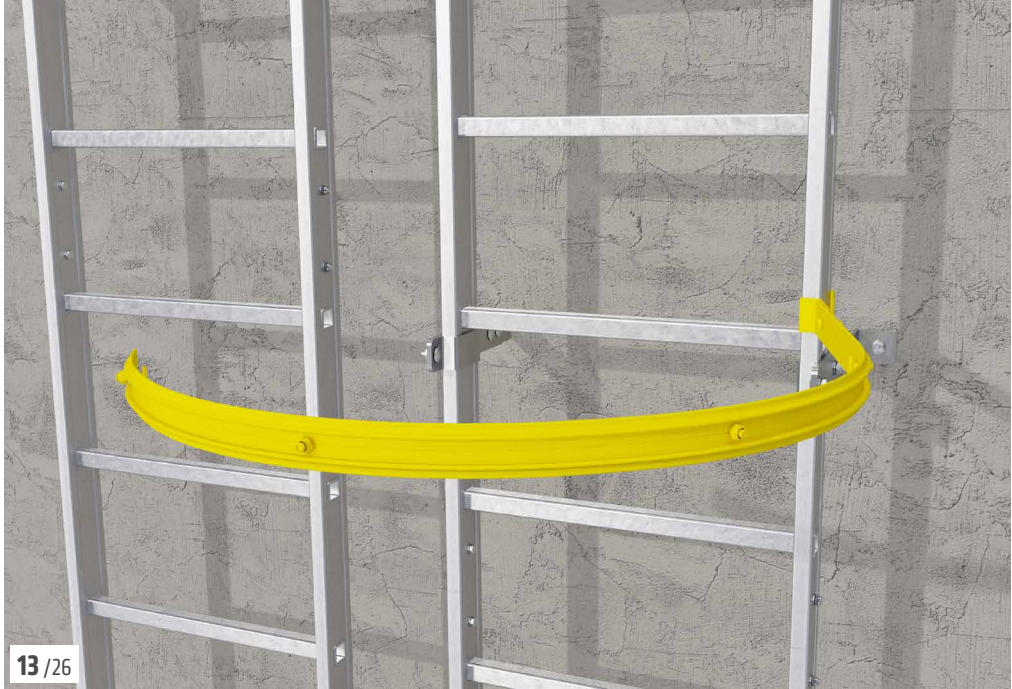

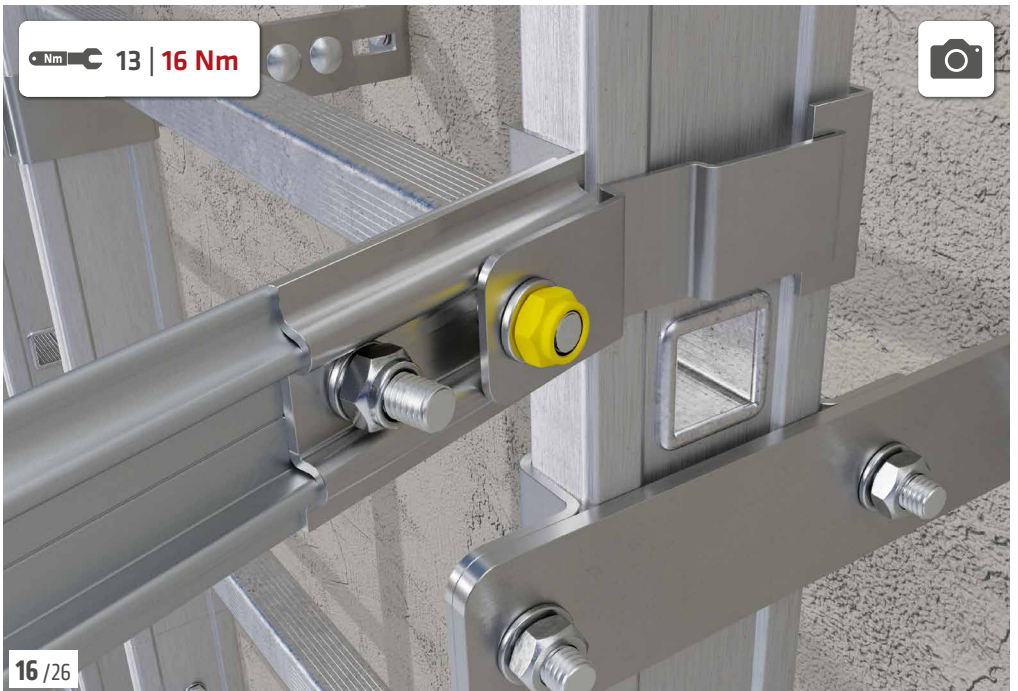

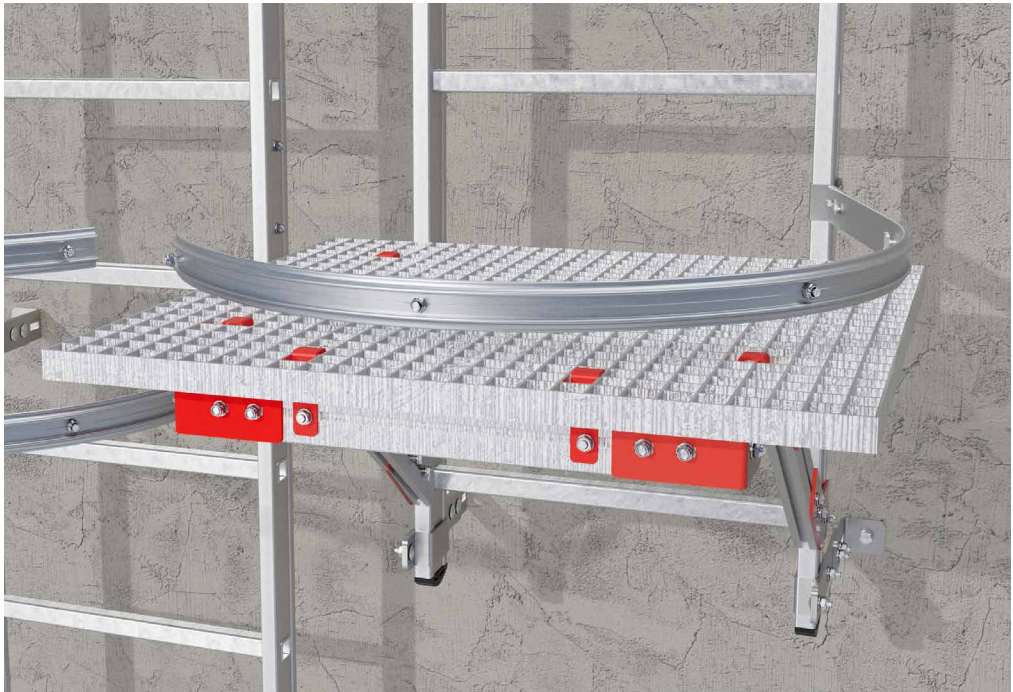

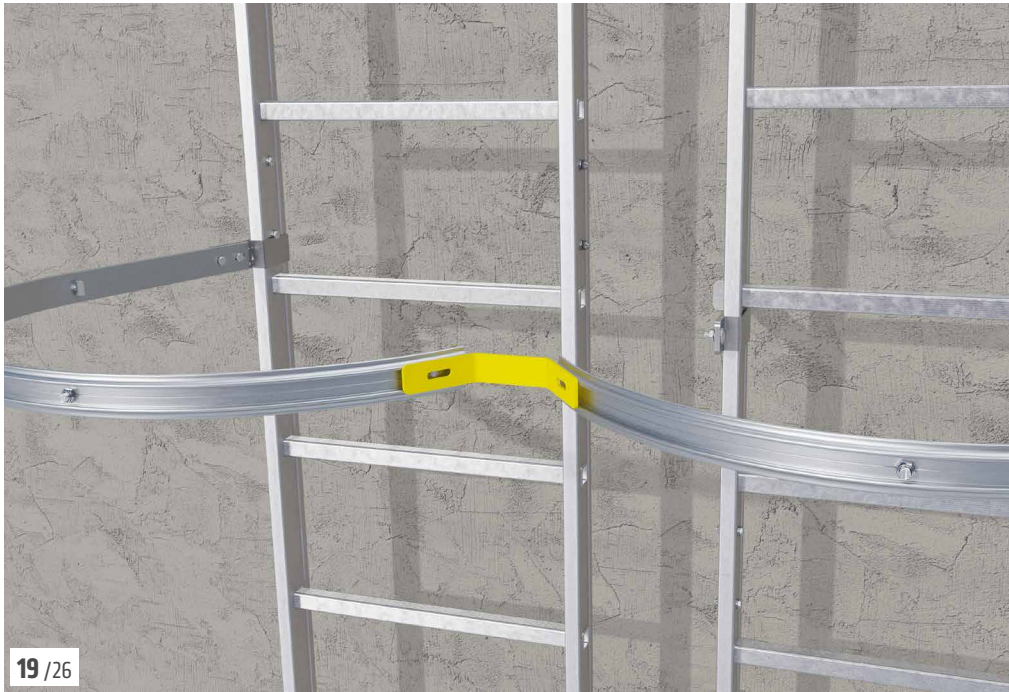

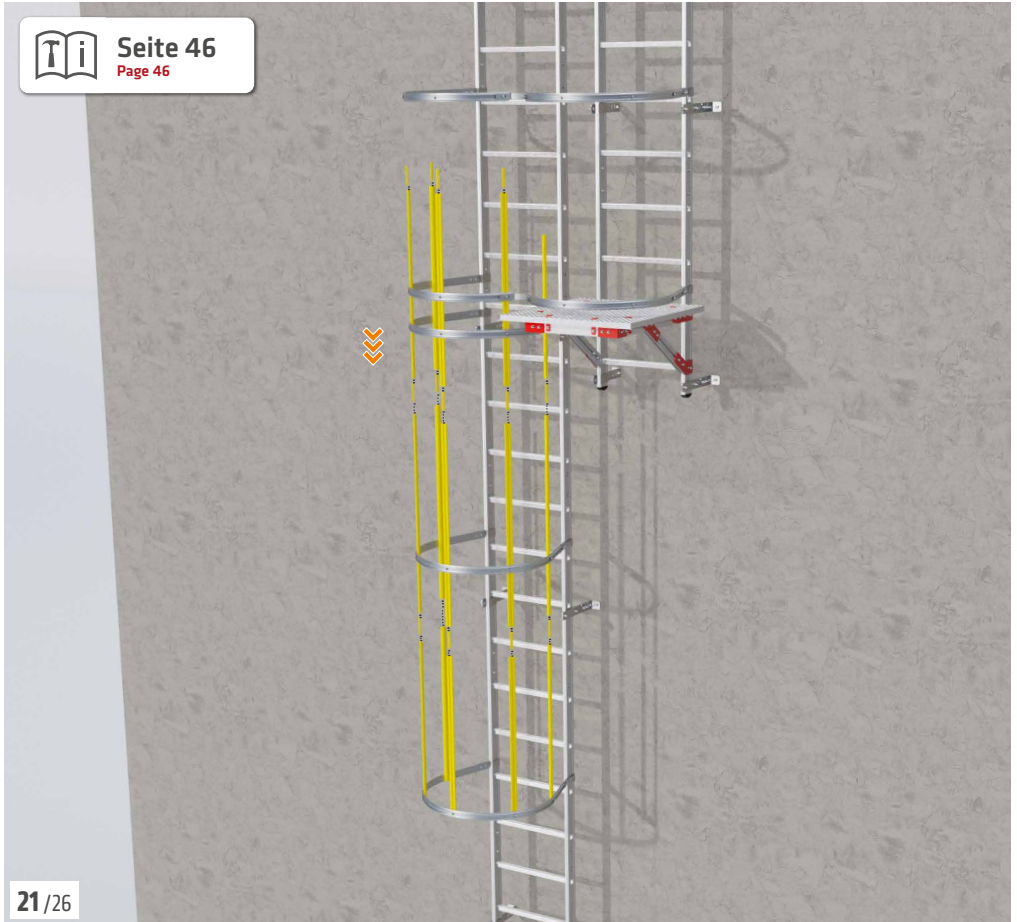

• Nm | 13 | 8 Nm



22 / 26

23 / 26



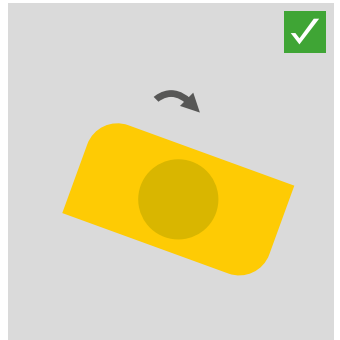

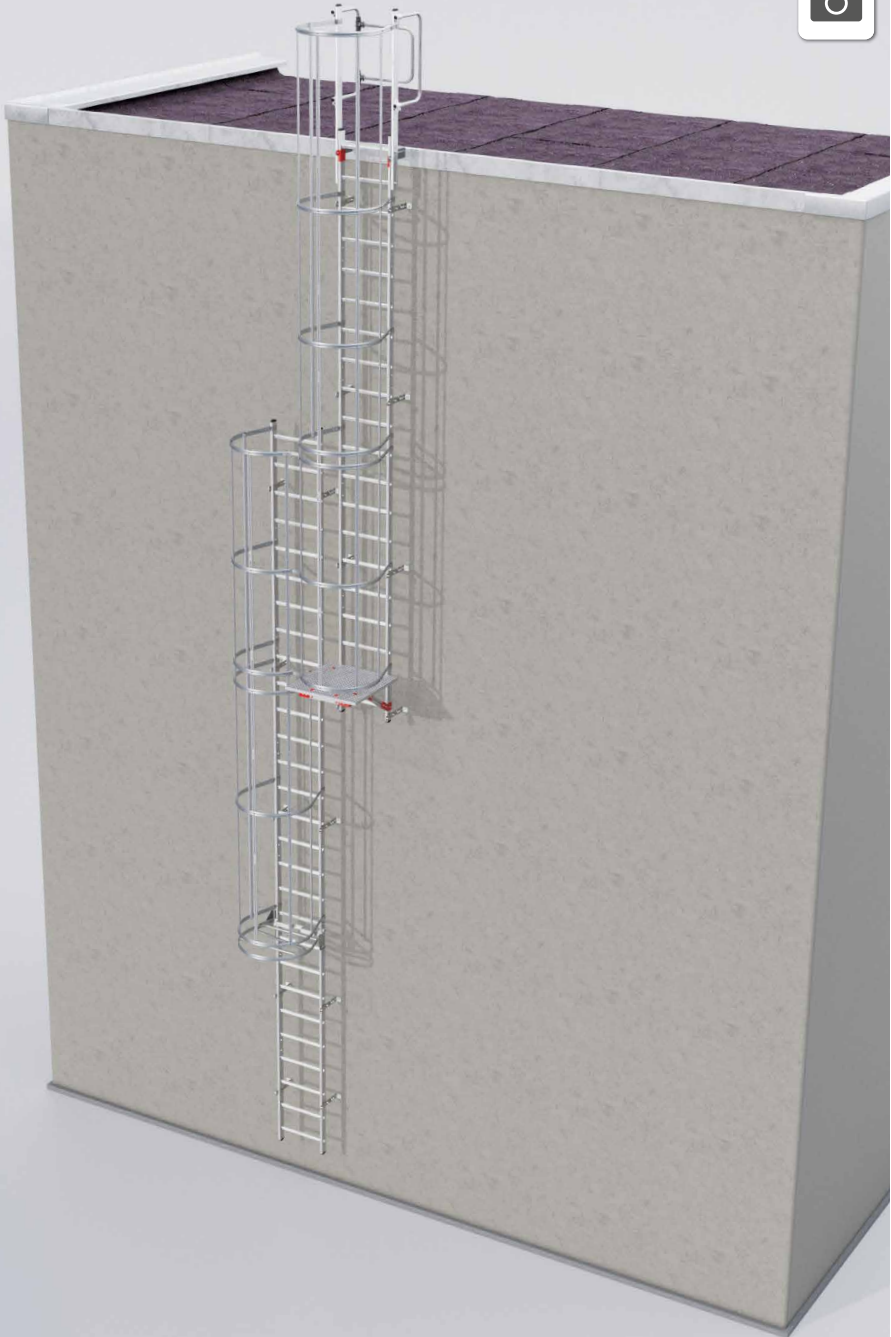



• Nm  13 | 16 Nm



2 / 10



3 / 10

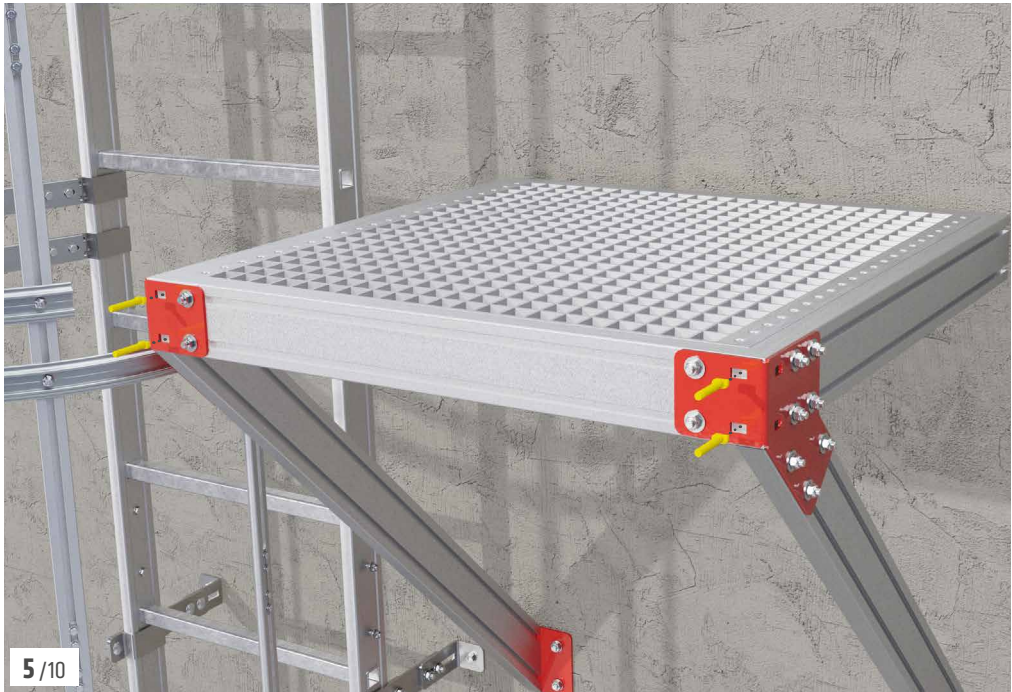
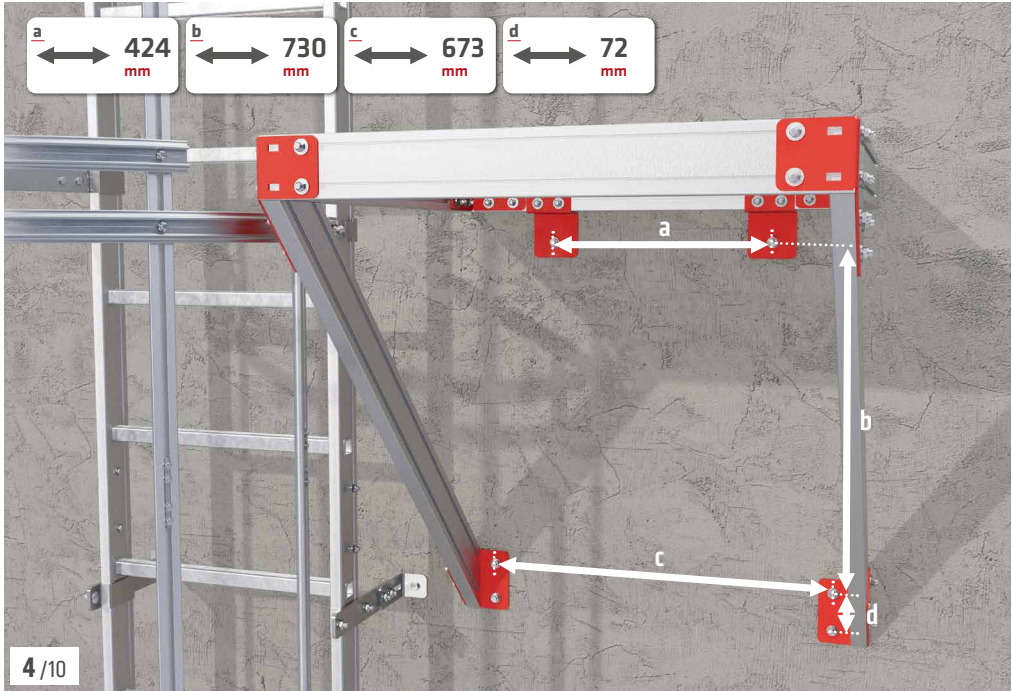

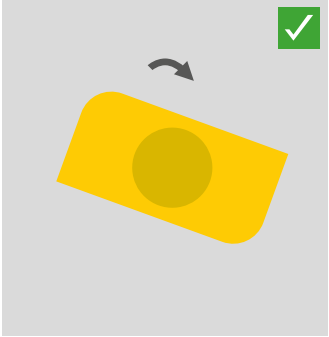
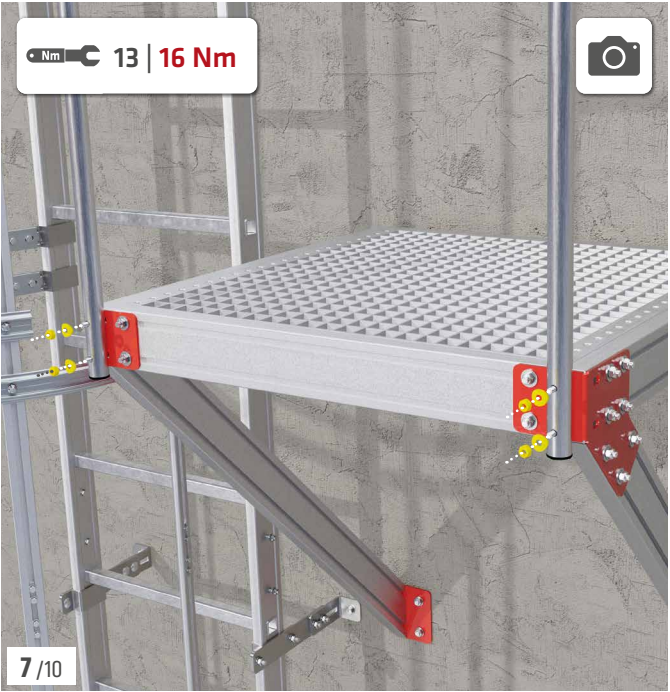

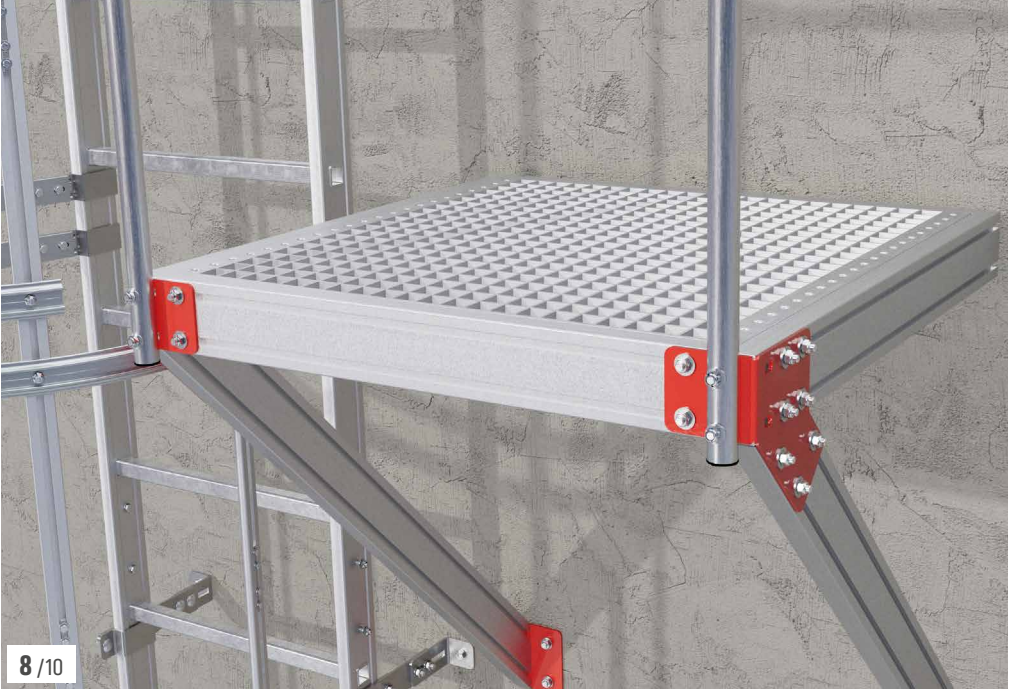

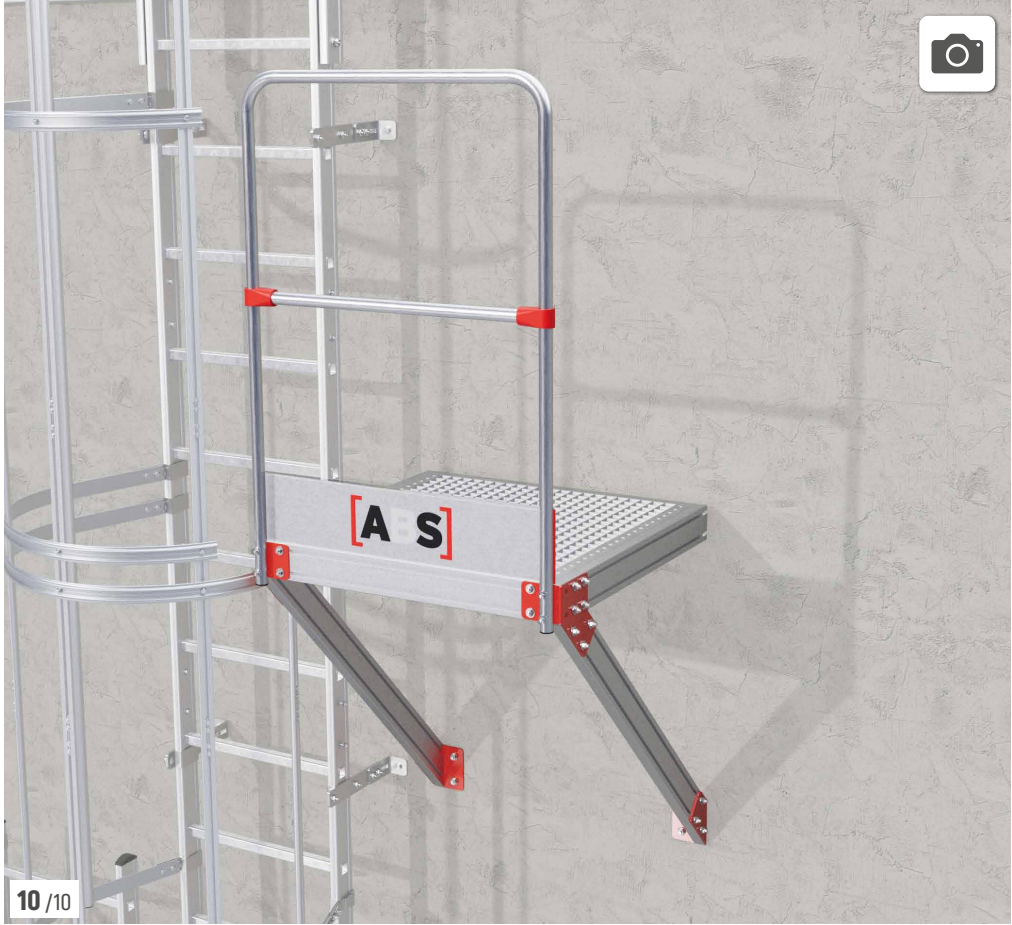

10 / 10

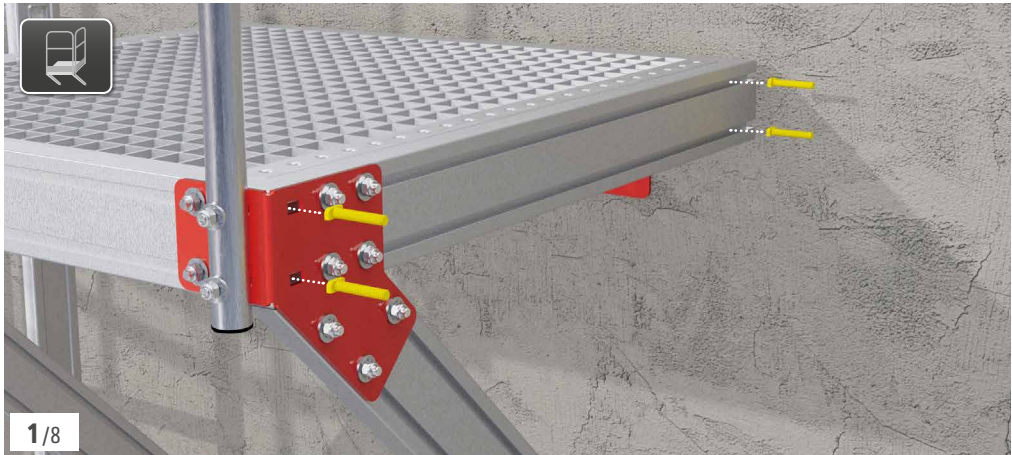

1 / 8

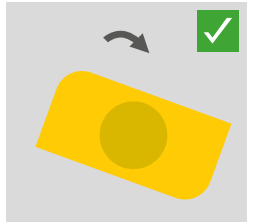
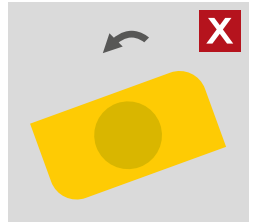
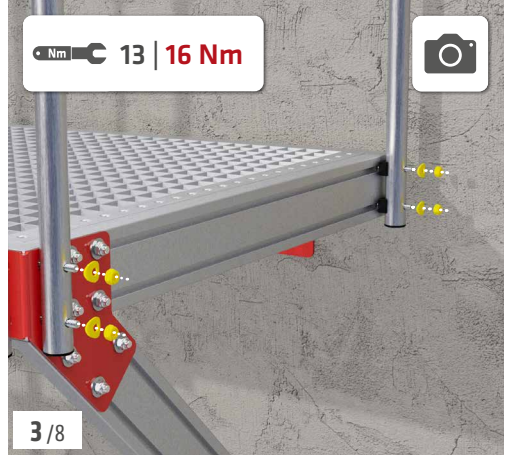

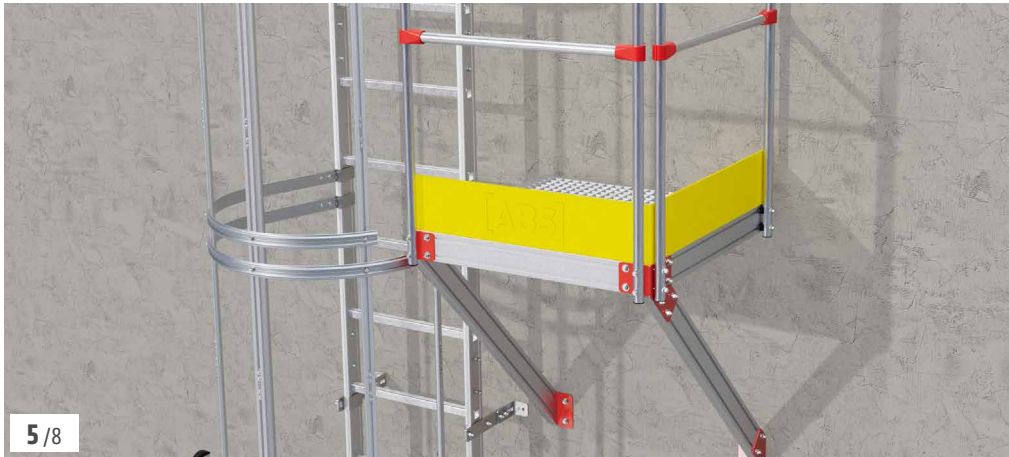



# ALWAYS ON TOP!

## ABS Safety GmbH

Gewerbering 3  
D-47623 Kevelaer  
Germany

Tel.: +49 28 32 972 81 - 0  
Fax: +49 28 32 972 81 - 285

info@absturzschutz.de

 [www.absturzschutz.de](http://www.absturzschutz.de)

 [.de/en](http://.de/en)

 [.de/fr](http://.de/fr)

 [.de/nl](http://.de/nl)



[instagram.com/abssafety](https://www.instagram.com/abssafety)



[youtube.com/abssafetygmbh](https://www.youtube.com/abssafetygmbh)



[facebook.com/ABS.Safety](https://www.facebook.com/ABS.Safety)



[linkedin.com/company/abs-safety-gmbh](https://www.linkedin.com/company/abs-safety-gmbh)



[xing.com/pages/abssafetygmbh](https://www.xing.com/pages/abssafetygmbh)