



ABS Treppenleiter

TL-XXX



MoA 327-03



DIN EN
ISO 14122-3

Werkzeuge | Tools



Sicherheitshinweise | Safety instructions



- DE** Montageanleitung beachten (1) und Sicherheitshinweise beachten (2).
- EN** Comply with the installation manual (1) and Comply with the safety instructions (2).
- FR** Respecter la notice de montage (1) and Respecter les consignes de sécurité (2).
- NL** Montagehandleiding in acht nemen (1) and Veiligheidsinstructies in acht nemen (2).
- BGR** Спазвайте инструкциите за монтаж (1) and Спазвайте инструкциите за безопасност (2).
- DK** Følg monteringsvejledningen (1) and Følg sikkerhedshenvisningerne (2).
- ET** Järgige paigaldusjuhendit (1) ja ohutusjuhiseid (2).
- FI** Noudata asennusohjeita (1) and Noudata turvallisuusohjeita (2).
- IT** Rispettare le istruzioni di montaggio (1) and Rispettare le istruzioni di sicurezza (2).
- PL** Przestrzegać zaleceń instrukcji montażu (1) and Przestrzegać zasad bezpieczeństwa (2).
- SK** Dodržujte návod na montáž (1) and Dodržujte bezpečnostné pokyny (2).
- SL** Sledite navodilom za namestitve (1) and Sledite varnostnim navodilom (2).
- ES** Observar las instrucciones de montaje (1) and Observar las indicaciones de seguridad (2).
- CS** Dodržujte návod k montáži (1) and Dodržujte bezpečnostní pokyny (2).
- HU** Vegye figyelembe az összeszerelési útmutatót (1) and Vegye figyelembe a biztonsági utasításokat (2).

Für eine ordnungsgemäße Montage ist eine Dokumentation des Einbaus zwingend erforderlich!
For a proper installation, a complete documentation of assembly is absolutely necessary.

Kontakte | Contact persons

Vertrieb & Technische Beratung
Sales & Technical Support

+49 (0) 28 32 - 972 81 - 0
vertrieb@absturzschutz.de

Schulung

Training
+49 (0) 28 32 - 972 81 - 148
schulung@absturzschutz.de

Montagevorbereitung

Assembly
+49 (0) 28 32 - 972 81 - 260
service@absturzschutz.de

Mustertypenschild | Sample label

[ABS] ABS SAFETY GMBH ³			
Kevelaer, Germany info@absturzschutz.de www.absturzschutz.de			
Typ / Produktbezeichnung ⁴		Chargennummer / Batch number ⁵	
Typ / Produktbezeichnung			
⁶ Normen / Standards	<input type="checkbox"/> -		
⁷ Max. Nutzer gleichzeitig	<input type="checkbox"/> -		
Max. No. of simultaneous users	<input type="checkbox"/> -		
¹¹ Modellnummer / Model number	<input type="checkbox"/> -		
¹⁴ 150 kg	<input type="checkbox"/> -		
<input type="checkbox"/> -	<input type="checkbox"/> -		
<input type="checkbox"/> -	<input type="checkbox"/> -		



Seite/
Page **15**



Seite/
Page **12**



Seite/
Page **14**



Seite/
Page **08**



Seite/
Page **09**



Seite/
Page **10**



Seite/
Page **06**



Seite/
Page **04**

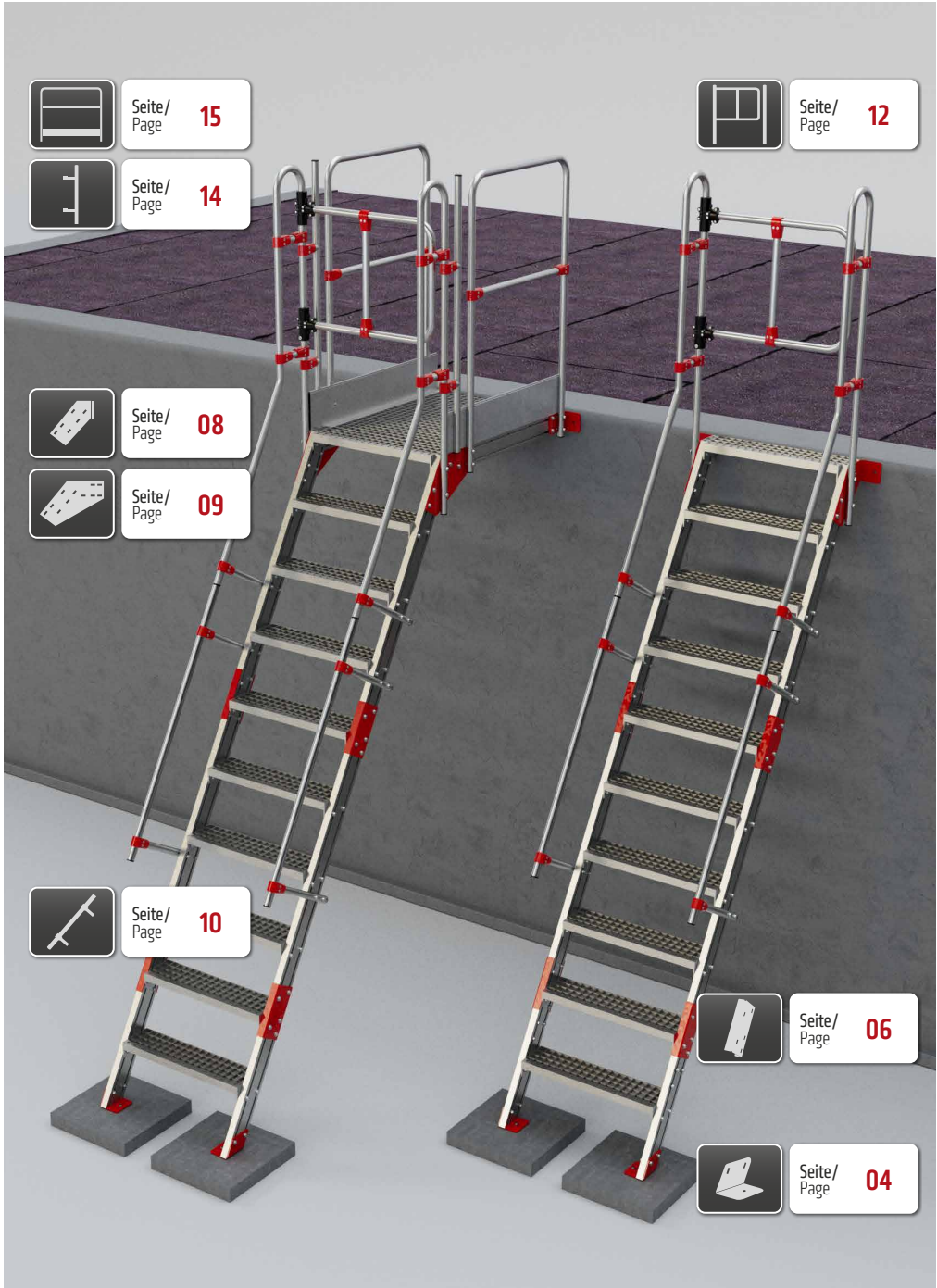



max.
150
kg

max.
300
kg



1/5



13 | 16 Nm



2/5

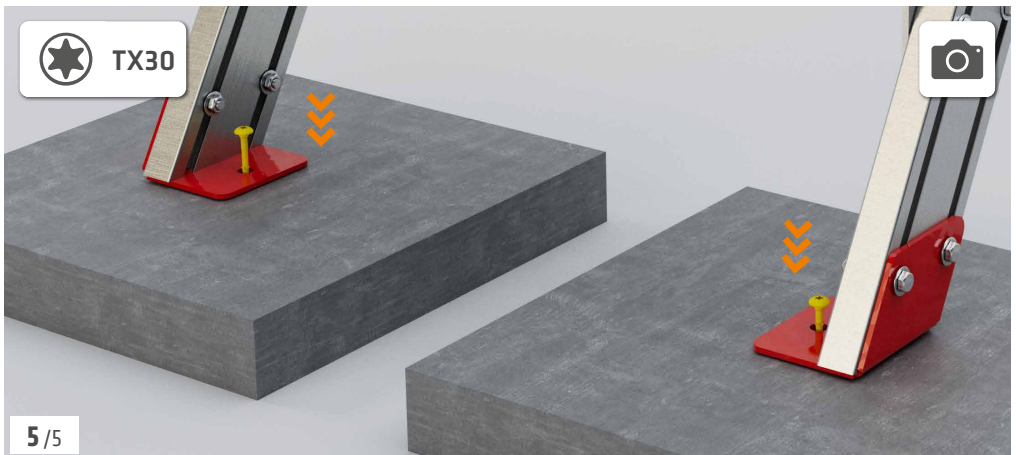
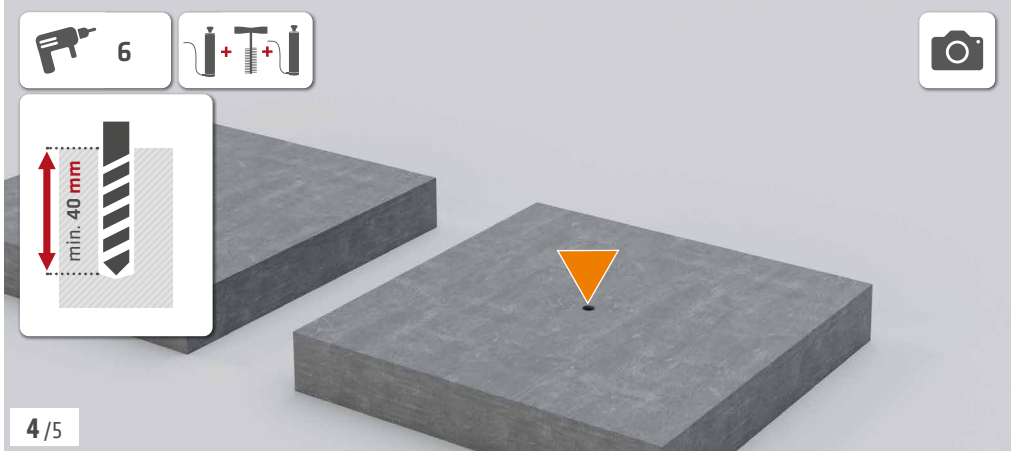

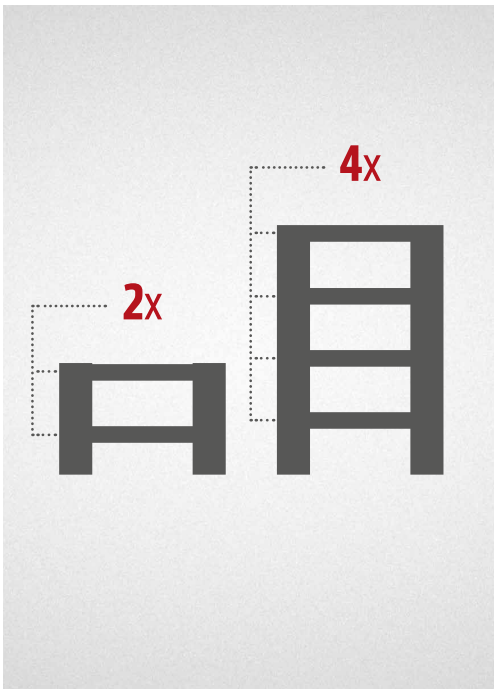
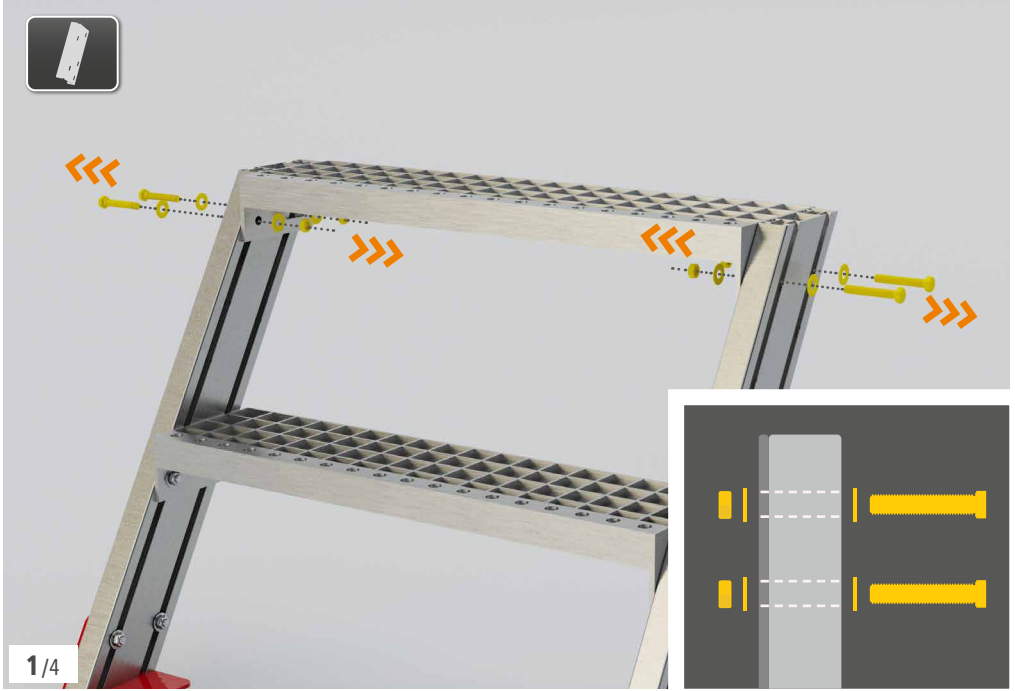

Nm 13 | 16 Nm

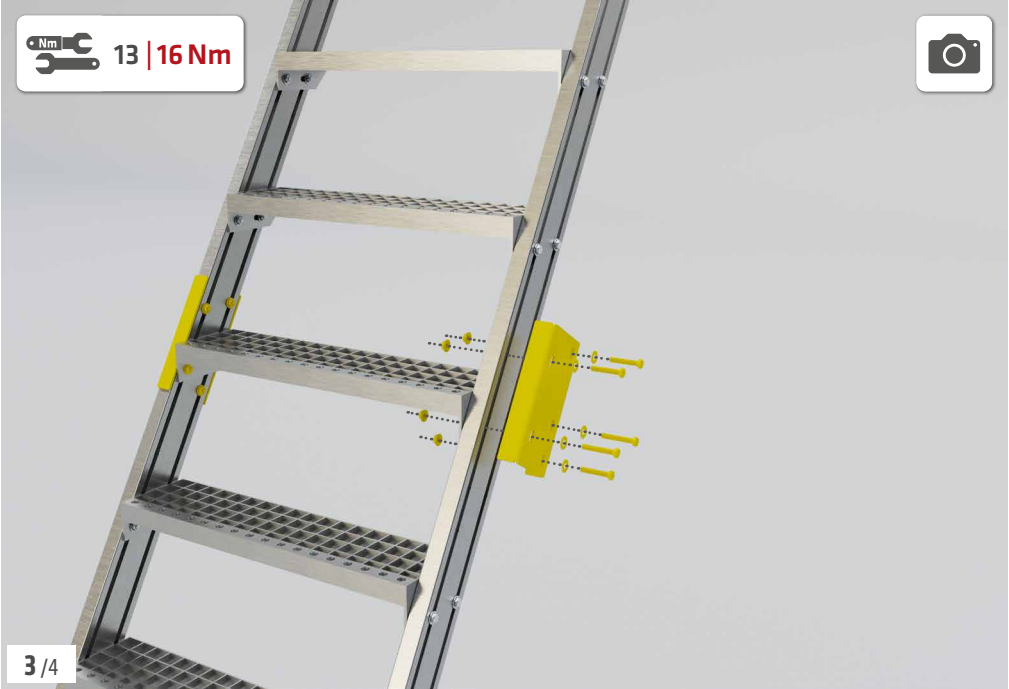

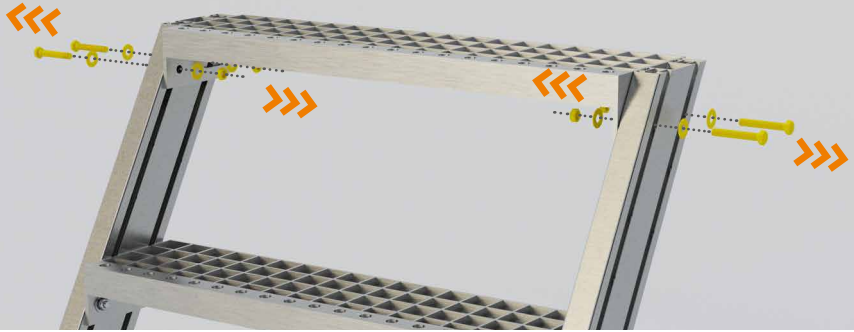

1/3

 Nm 13 | 16 Nm

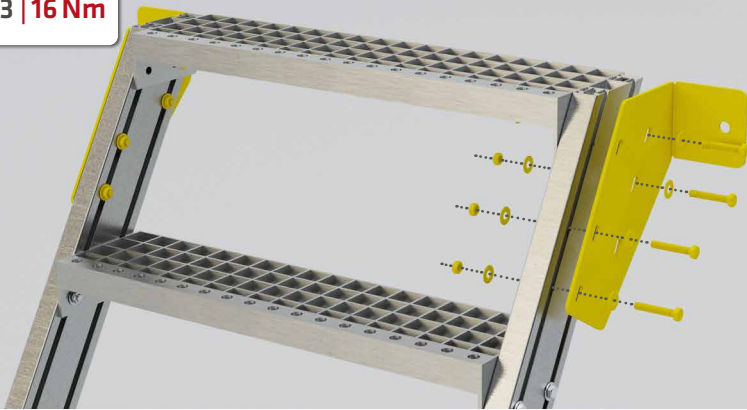

2/3



3/3

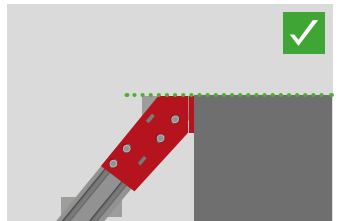
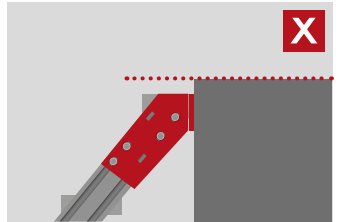

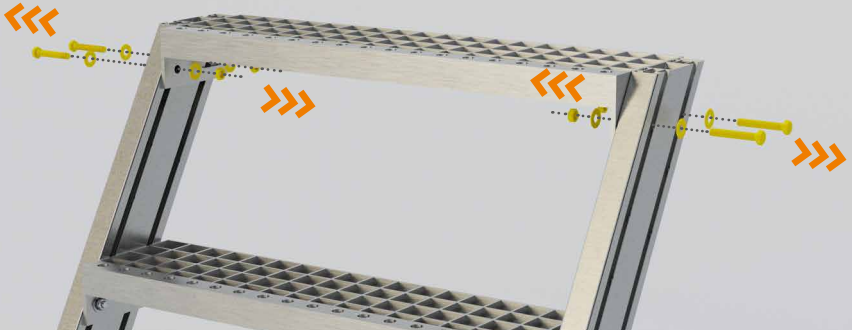

1/3

 Nm 13 | 16 Nm

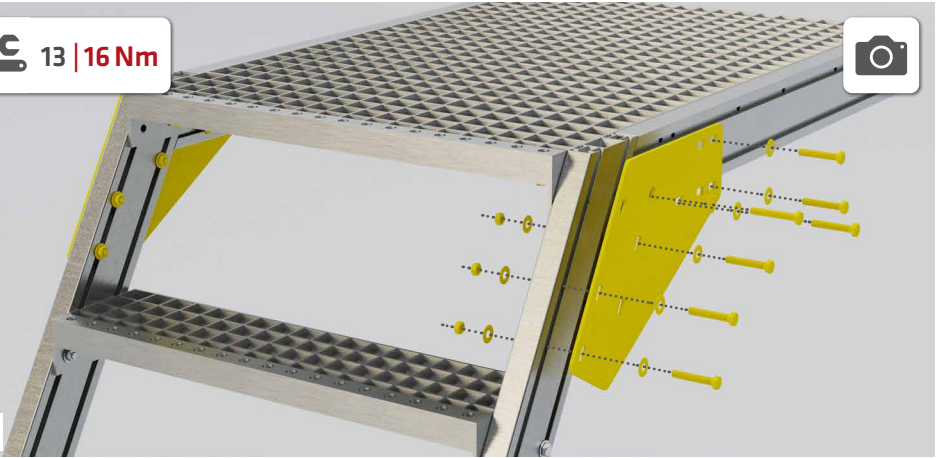

2/3

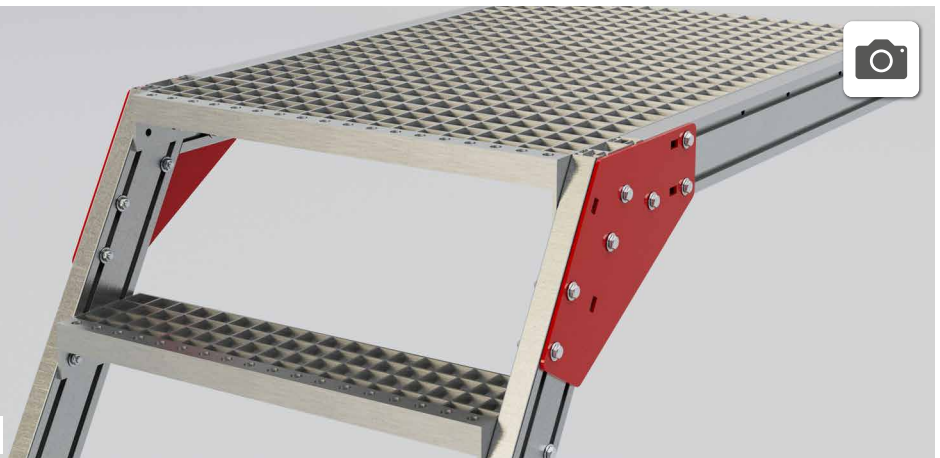

3/3



1/6



13 | 16 Nm

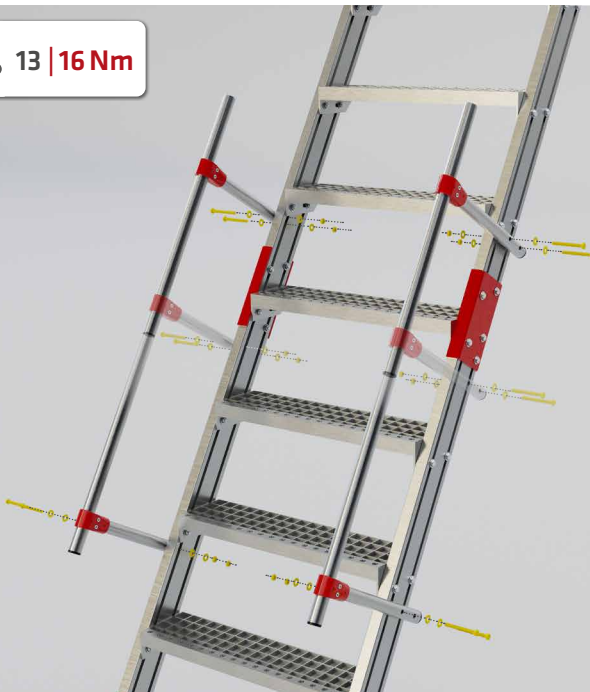

2/6



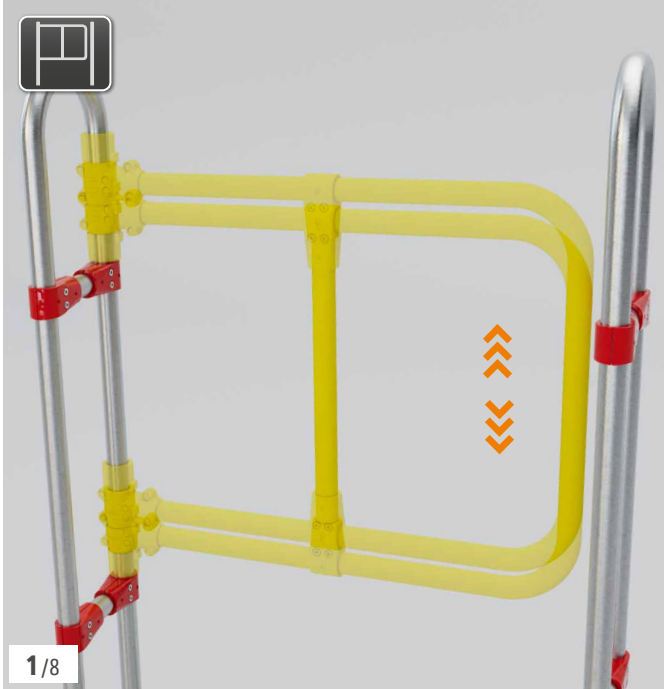

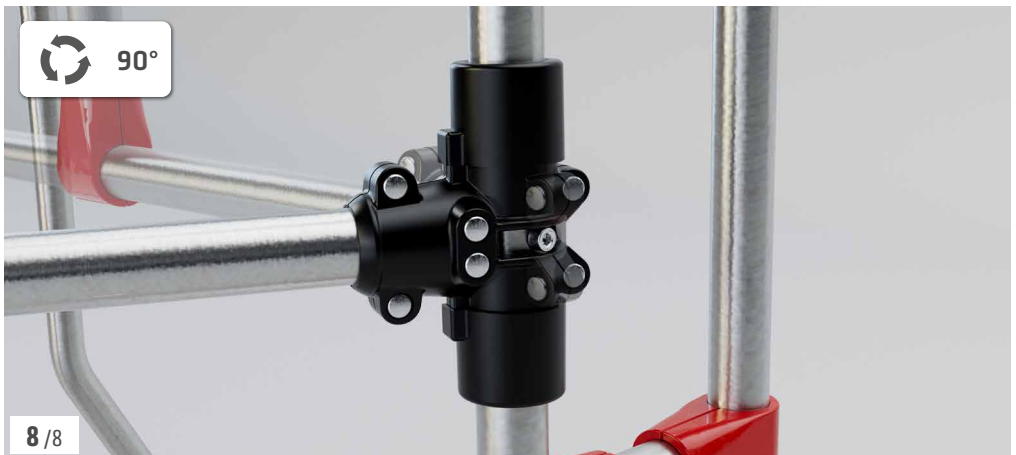
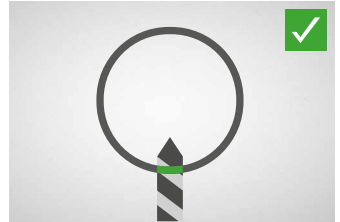
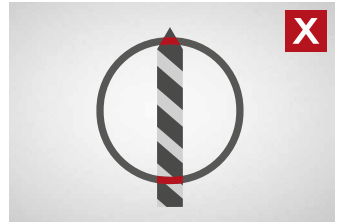
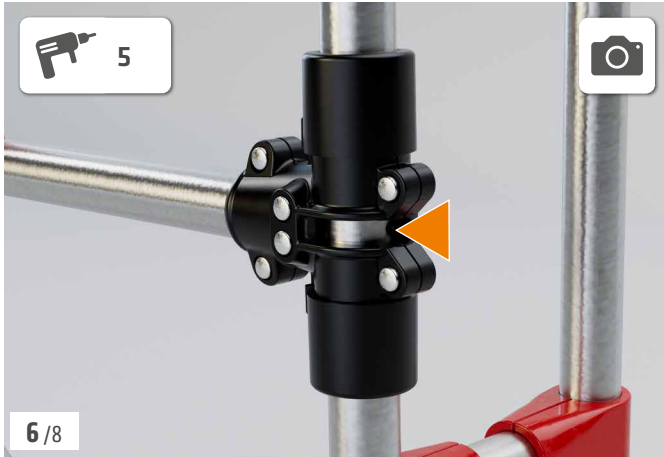





Nm 13 | 16 Nm

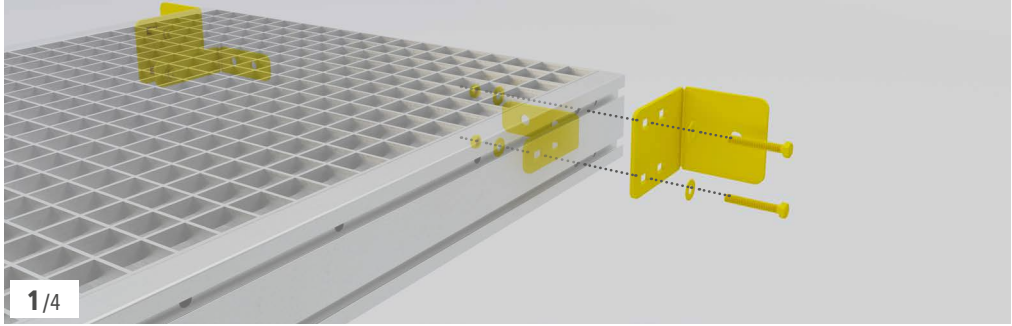

1/4

Nm 13 | 16 Nm



2/4



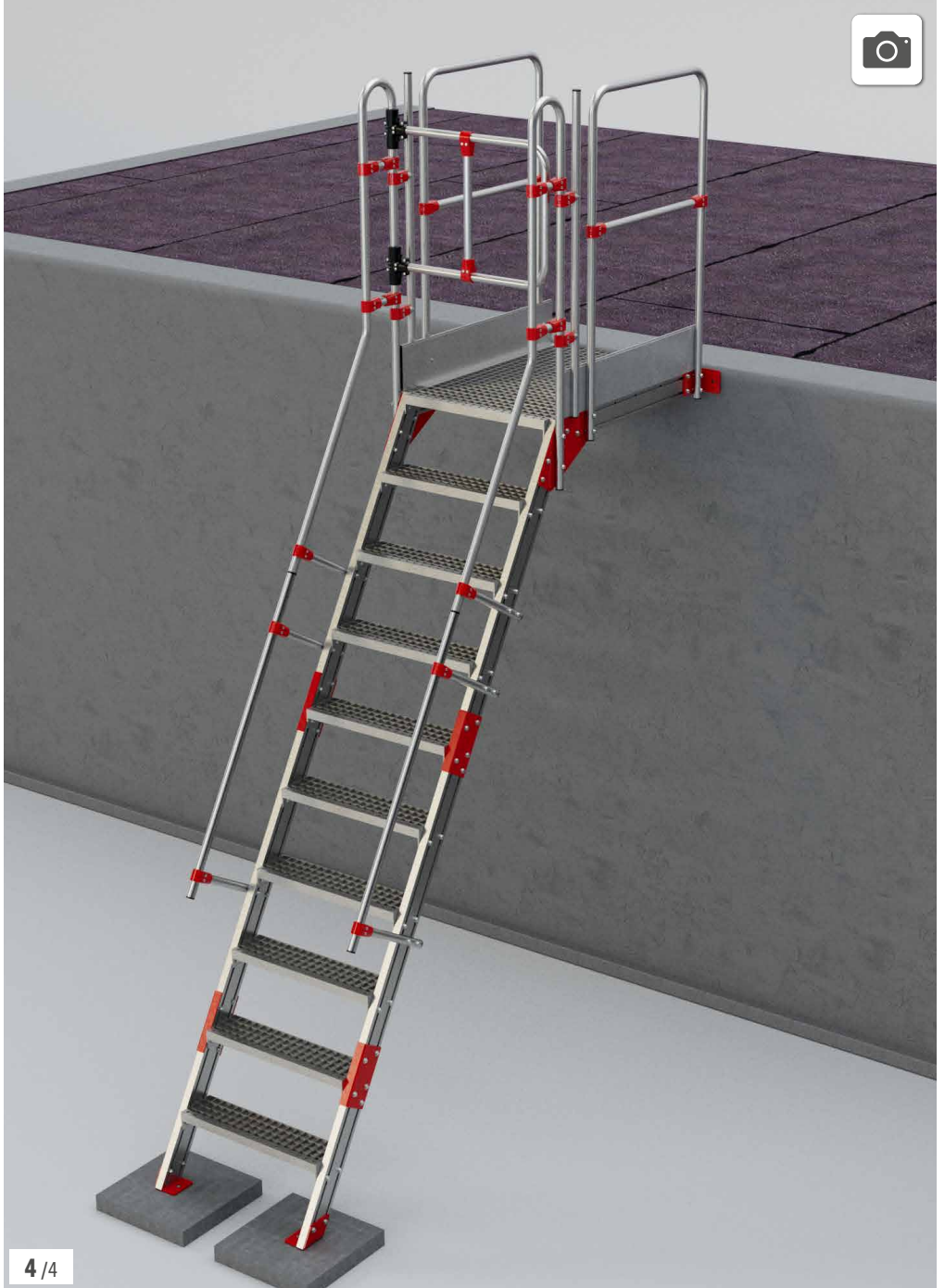

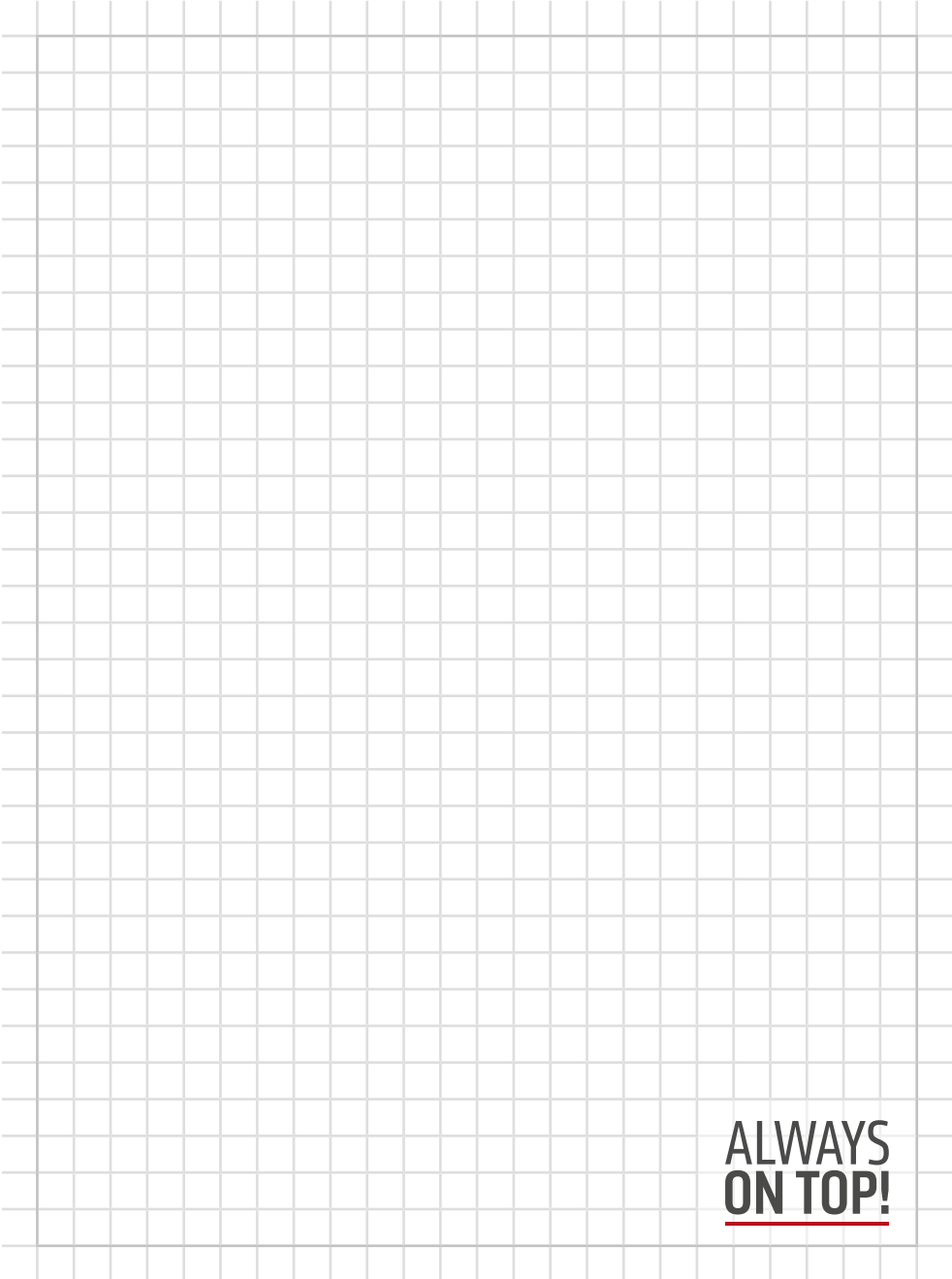

**ALWAYS
ON TOP!**

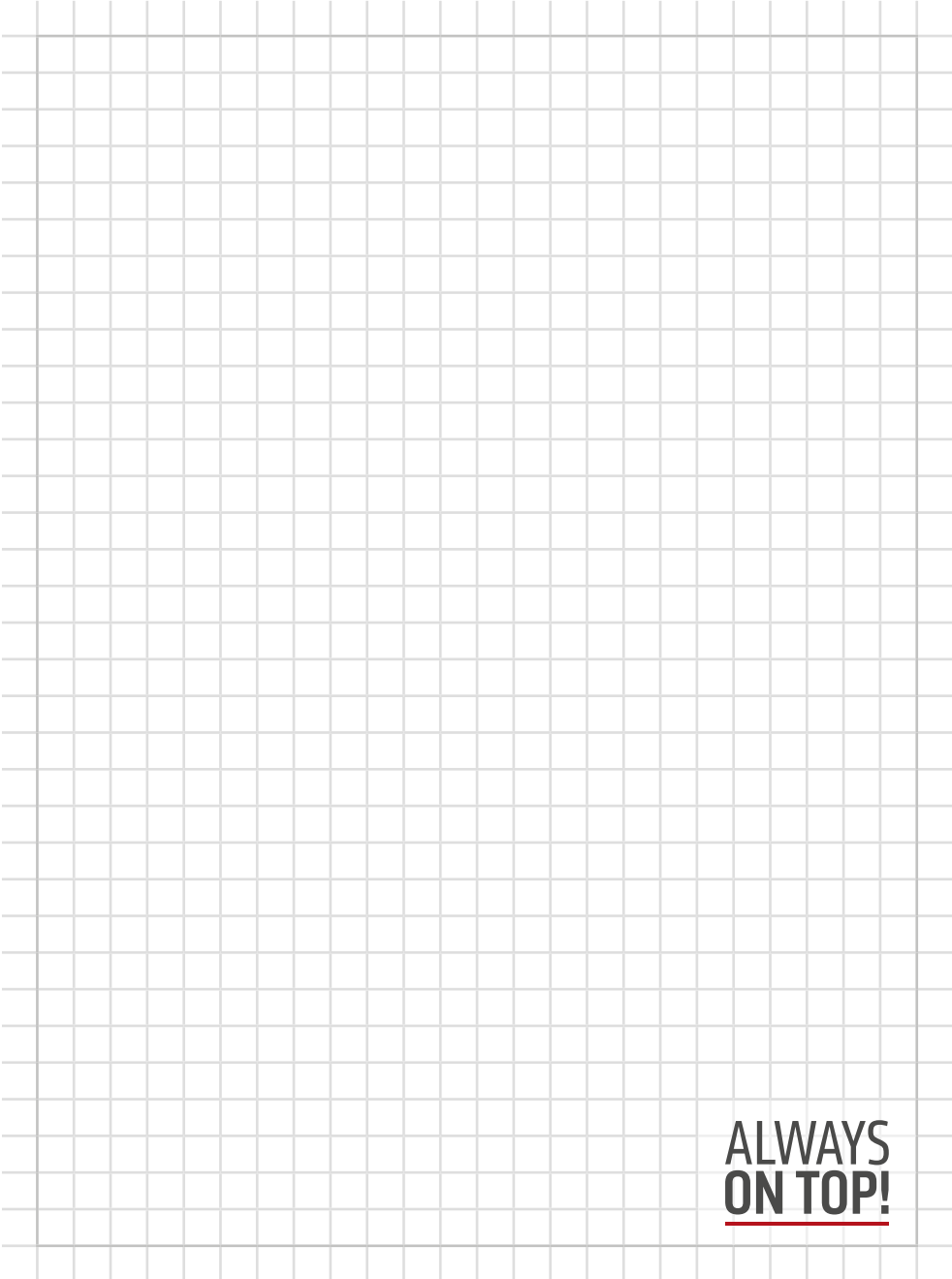

**ALWAYS
ON TOP!**

ALWAYS ON TOP!

ABS Safety GmbH

Gewerbering 3
D-47623 Kevelaer
Germany

Tel.: +49 28 32 972 81 - 0
Fax: +49 28 32 972 81 - 285

info@absturzschutz.de

 www.absturzschutz.de

 .de/en

 .de/fr

 .de/nl



[instagram.com/abssafety](https://www.instagram.com/abssafety)



[youtube.com/abssafetygmbh](https://www.youtube.com/abssafetygmbh)



[facebook.com/ABS.Safety](https://www.facebook.com/ABS.Safety)



[linkedin.com/company/abs-safety-gmbh](https://www.linkedin.com/company/abs-safety-gmbh)



[xing.com/pages/abssafetygmbh](https://www.xing.com/pages/abssafetygmbh)