

[ABS]

ABS-Lock[®] SYS IV

für/for ABS Base Weight



MoA 323-03



Werkzeuge | Tools



Sicherheitshinweise | Safety instructions



- DE** Montageanleitung beachten (1) und Sicherheitshinweise beachten (2).
- EN** Comply with the installation manual (1) and Comply with the safety instructions (2).
- FR** Respecter la notice de montage (1) and Respecter les consignes de sécurité (2).
- NL** Montagehandleiding in acht nemen (1) and Veiligheidsinstructies in acht nemen (2).
- BGR** Спазвайте инструкциите за монтаж (1) and Спазвайте инструкциите за безопасност (2).
- DK** Følg monteringsvejledningen (1) and Følg sikkerhedshenvisningerne (2).
- ET** Järgige paigaldusjuhendit (1) ja ohutusjuhiseid (2).
- FI** Noudata asennusohjeita (1) and Noudata turvallisuusohjeita (2).
- IT** Rispettare le istruzioni di montaggio (1) and Rispettare le istruzioni di sicurezza (2).
- PL** Przestrzegać zaleceń instrukcji montażu (1) and Przestrzegać zasad bezpieczeństwa (2).
- SK** Dodržujte návod na montáž (1) and Dodržujte bezpečnostné pokyny (2).
- SL** Sledite navodilom za namestitve (1) and Sledite varnostnim navodilom (2).
- ES** Observar las instrucciones de montaje (1) and Observar las indicaciones de seguridad (2).
- CS** Dodržujte návod k montáži (1) and Dodržujte bezpečnostní pokyny (2).
- HU** Vegye figyelembe az összeszerelési útmutatót (1) and Vegye figyelembe a biztonsági utasításokat (2).

Für eine ordnungsgemäße Montage ist eine Dokumentation des Einbaus zwingend erforderlich!
For a proper installation, a complete documentation of assembly is absolutely necessary.

Kontakte | Contact persons

Vertrieb & Technische Beratung
Sales & Technical Support
+49 (0) 28 32 - 972 81 - 0
vertrieb@absturzschutz.de

Schulung
Training
+49 (0) 28 32 - 972 81 - 148
schulung@absturzschutz.de

Montagevorbereitung
Assembly
+49 (0) 28 32 - 972 81 - 260
service@absturzschutz.de

Mustertypenschild | Sample label

[ABS]

ABS SAFETY GMBH 3

Kevelaer, Germany
info@absturzschutz.de
www.absturzschutz.de

1
2

Mustertypenschild /
Sample only

Chargennummer /
Batch number

6	Normen / Standards	-
7	Max. Nutzer gleichzeitig (DIN EN 795:2012) Max. No. of simultaneous users	-
11	Modellnummer / Model number	-
-	-	-
-	-	-
-	-	-

CE

0158

[ABS]

Z-14.9-688

9

10

Montageschritte dokumentieren

Document assembly step



Dokumentation mit Bildern vervollständigen!
Complete your documentation using pictures!

**Dokumentation
ist Pflicht!**

Documentation is compulsory!

Inhalt | Content

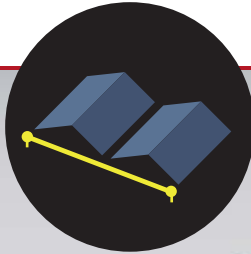
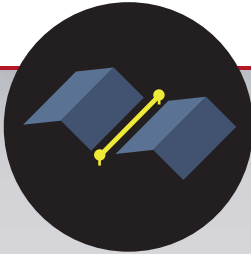

Seite/
Page **21-22**



Seite/
Page **21-22**

Seite/
Page **12**



Seite/
Page **20-22**



Seite/
Page **18**



Seite/
Page **17**



Seite/
Page **8**

Seite/
Page **30**



Seite/
Page **29**



Seite/
Page **24**

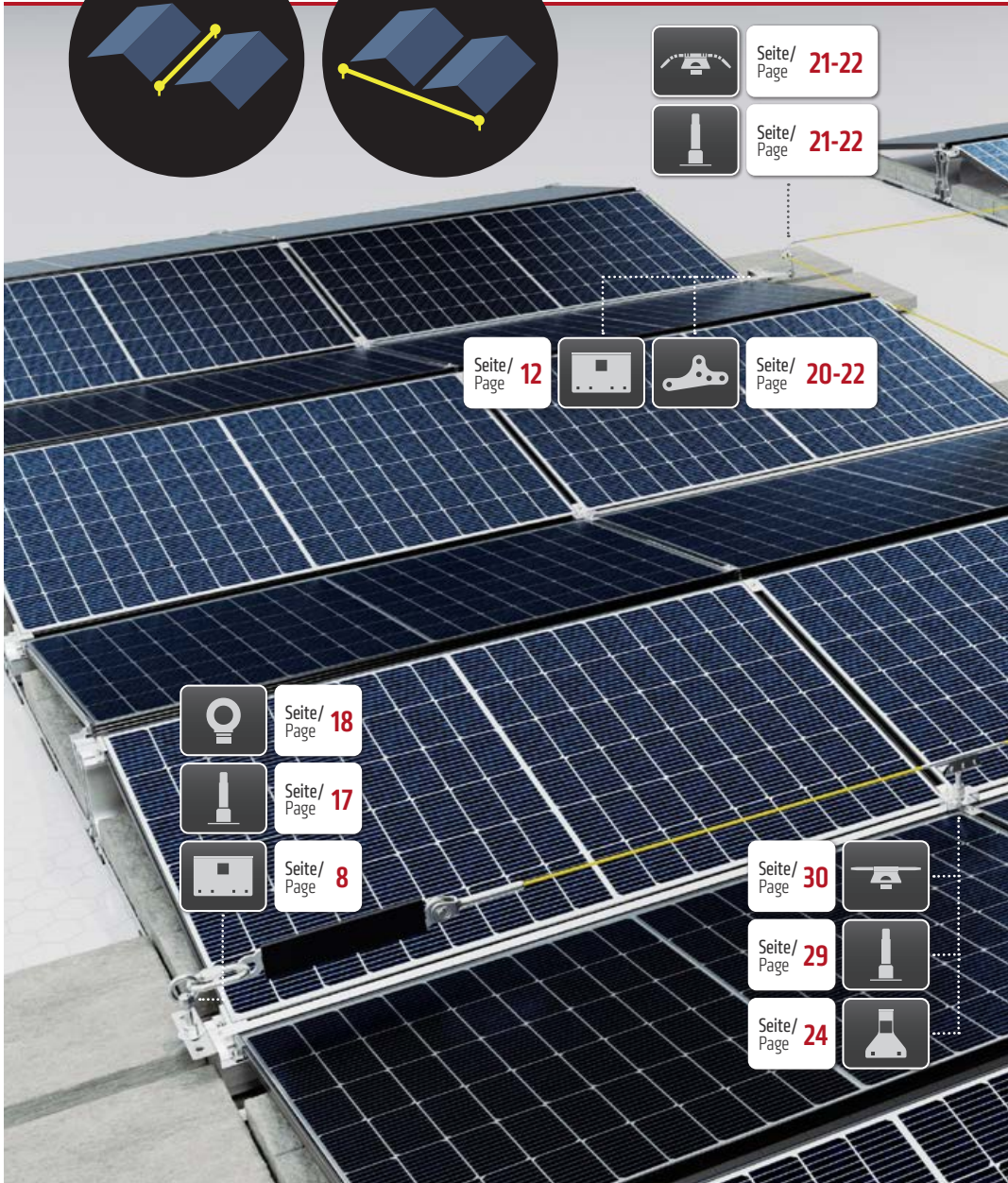

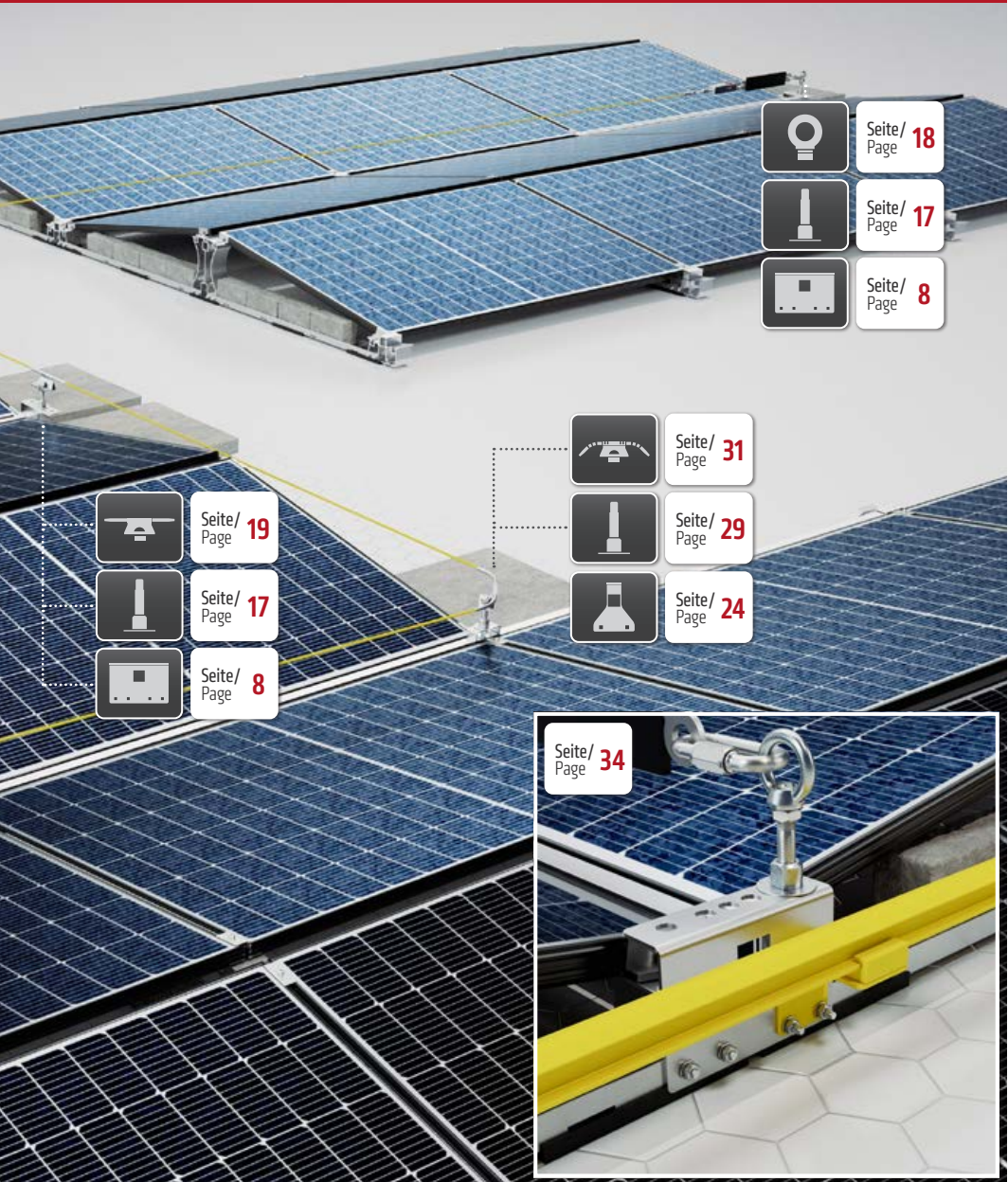

Seite/
Page **18**



Seite/
Page **17**



Seite/
Page **8**



Seite/
Page **31**



Seite/
Page **29**



Seite/
Page **24**



Seite/
Page **19**



Seite/
Page **17**



Seite/
Page **8**



Seite/
Page **34**



a  min. **108**
kg

b  min. **1020**
kg

c  min. **5343**
mm

 min. **12** x

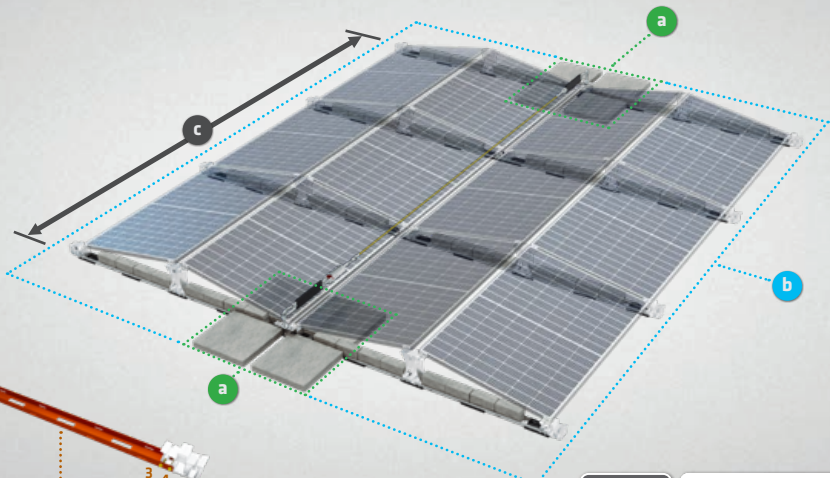

Jedes einzelne Profil muss immer mit 4 Schrauben befestigt werden.

Each individual profile must always be fastened with 4 screws.



 **MoA 316**
ABS Base Weight

a  max. **9000**
mm

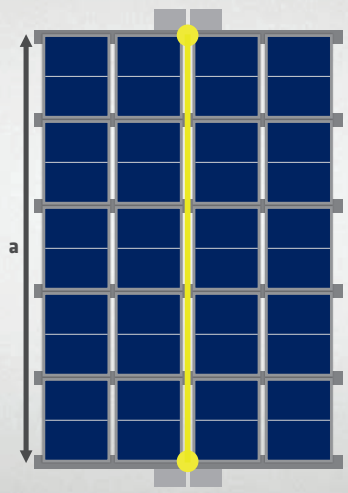

a  max. **9000**
mm

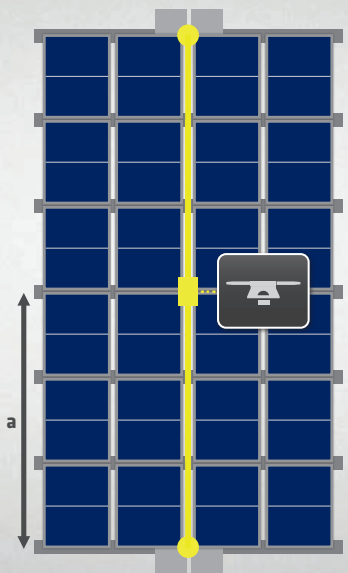



a  min. **108**
kg

b  min. **1020**
kg

c  min. **4728**
mm

 min. **8 x**



Jedes einzelne Profil muss immer mit 4 Schrauben befestigt werden.
Each individual profile must always be fastened with 4 screws.



 **MoA 316**
ABS Base Weight

a  max. **7000**
mm

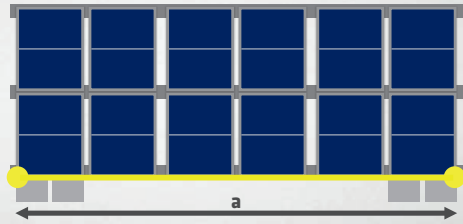

a  max. **7000**
mm

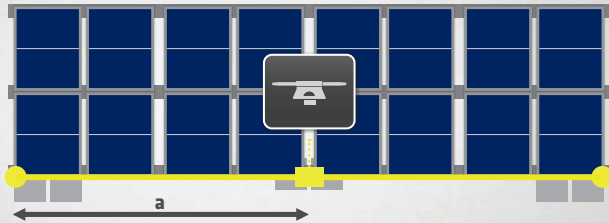

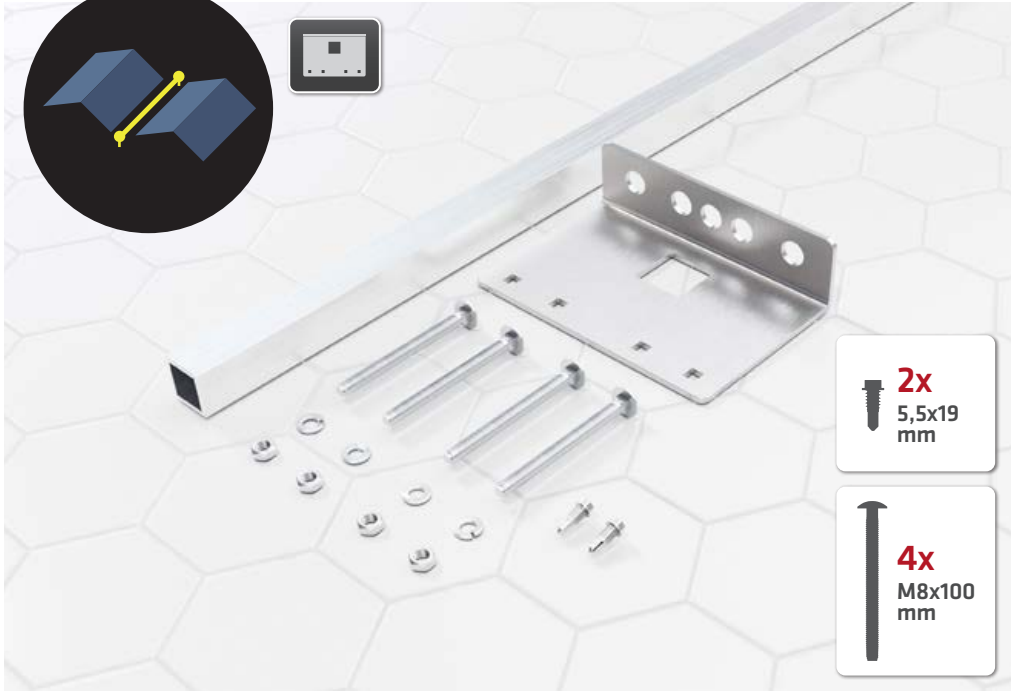

2x
5,5x19
mm

4x
M8x100
mm







5/8

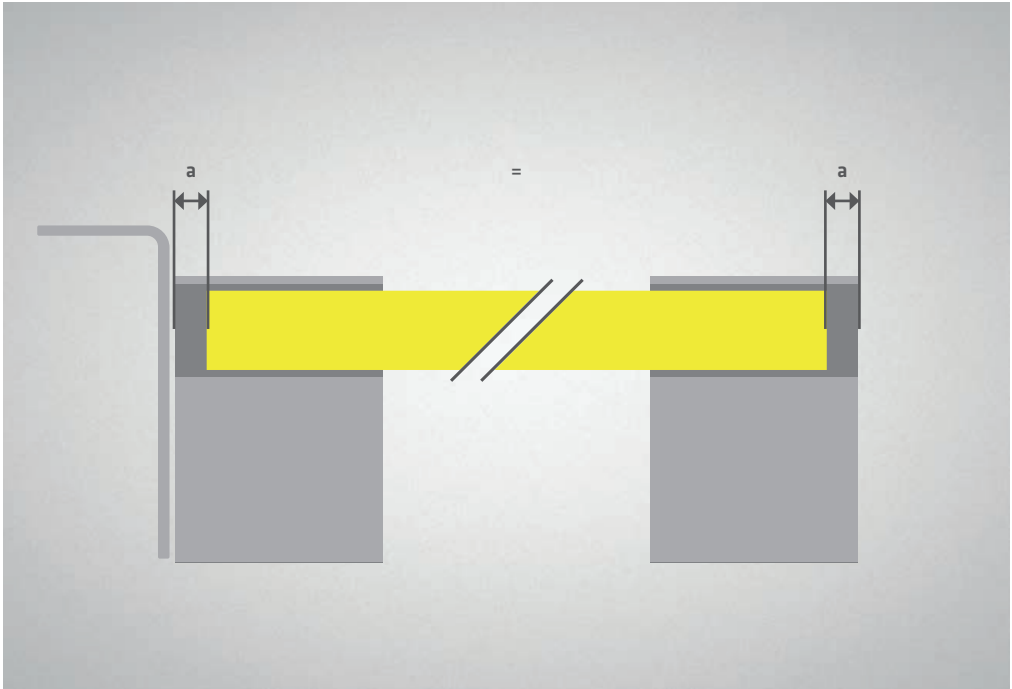









5/8

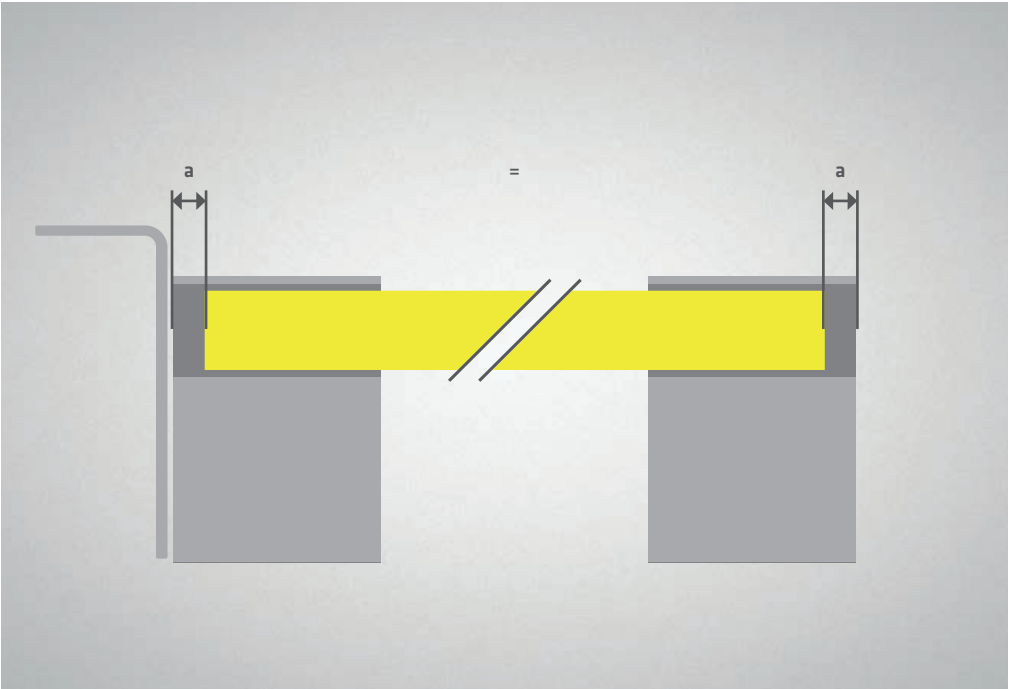



Inhalt | Content

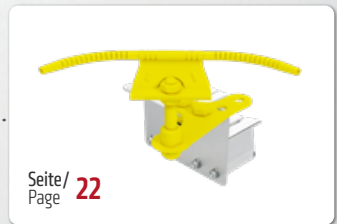
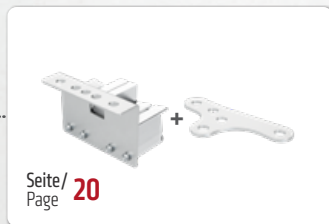
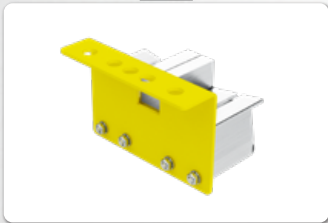
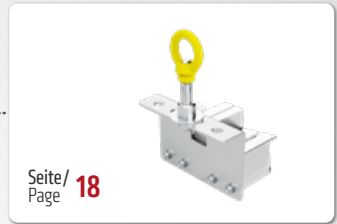
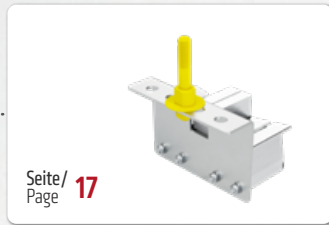













MoA 243
ABS-Lock® SYS II-IV



Überzieher / Cover
ABS-Lock® SYS II+IV



MoA 243
ABS-Lock® SYS II-IV



Überzieher / Cover
ABS-Lock® SYS II+IV



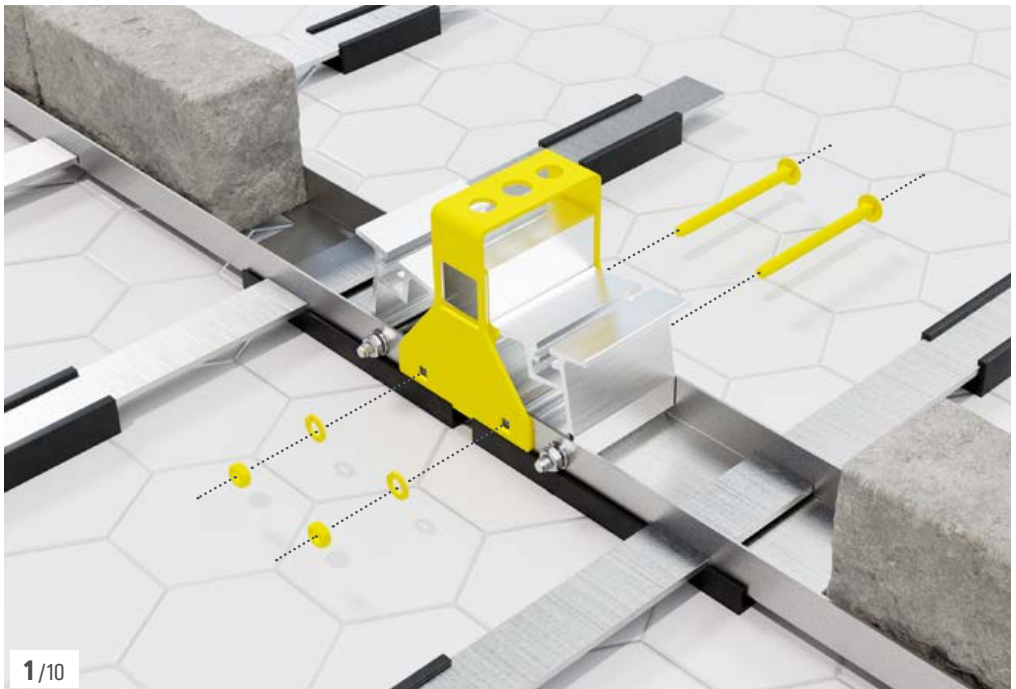

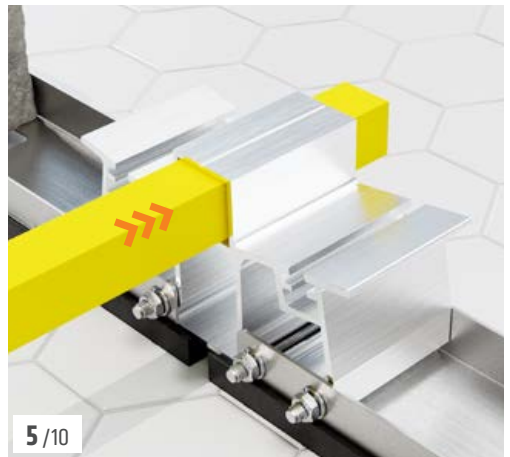

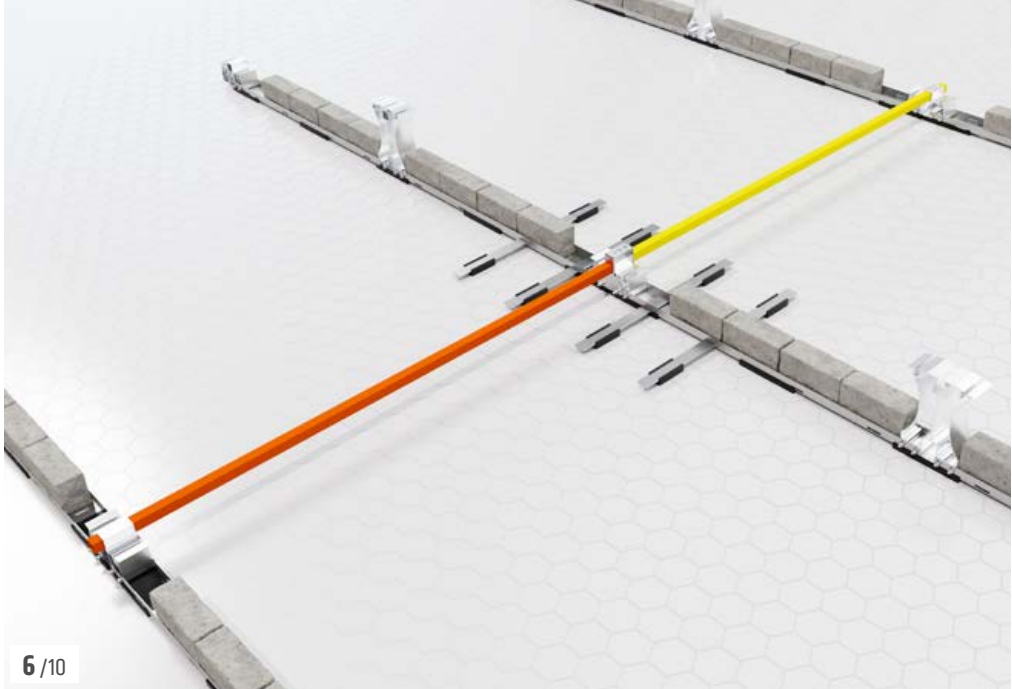

6 /10

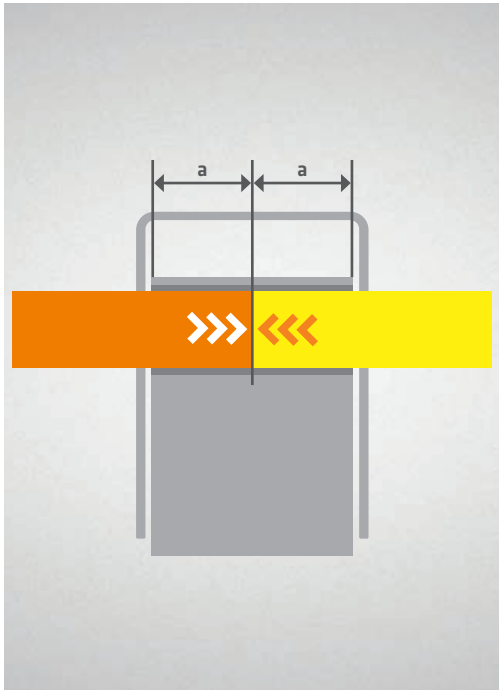

SW 5,5



7 /10



Inhalt | Content

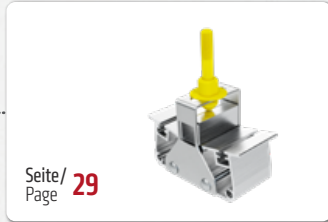

Seite/
Page 29



Seite/
Page 30



Seite/
Page 31



Seite/
Page 32

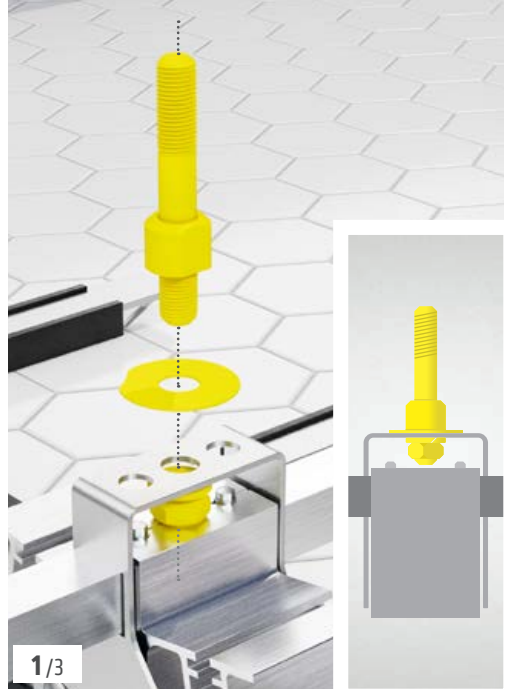











MoA 321
ABS Solar Guard mobile



ABS Solar Guard mobile
für/for ABS Base Weight



2x
M8x110
mm

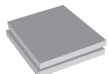
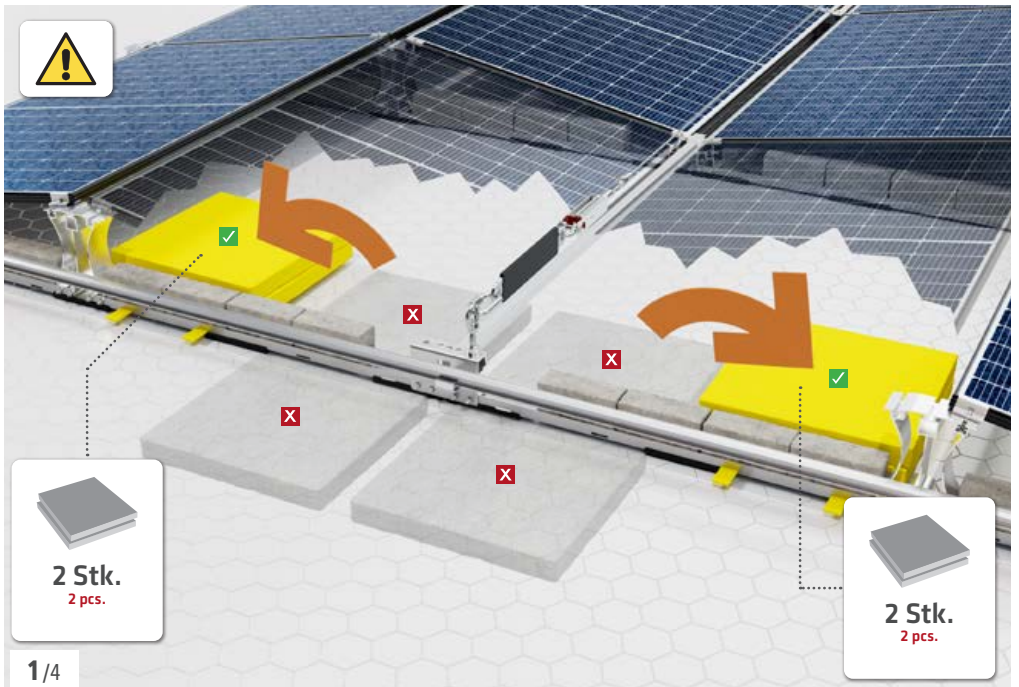

2 Stk.
2 pcs.

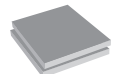

2 Stk.
2 pcs.

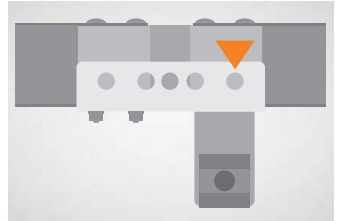
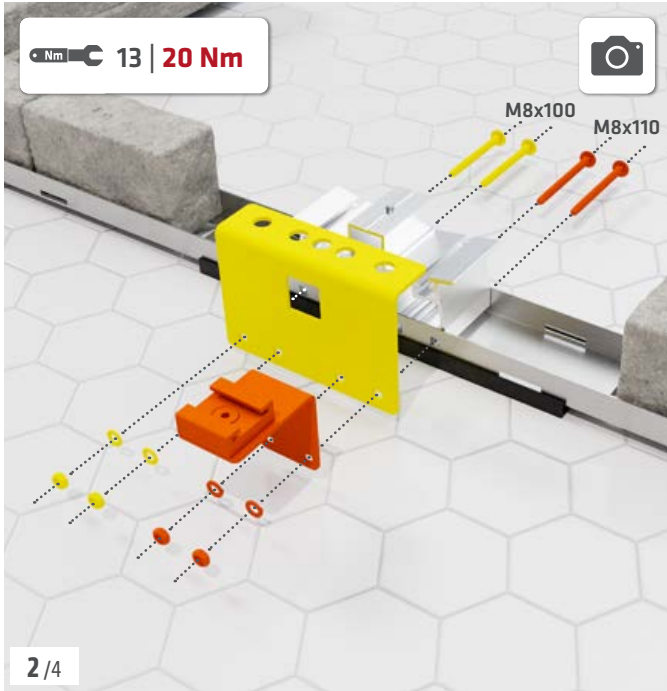

ALWAYS ON TOP!

ABS Safety GmbH

Gewerbering 3
D-47623 Kevelaer
Germany

Tel.: +49 28 32 972 81 - 0
Fax: +49 28 32 972 81 - 285

info@absturzschutz.de

 www.absturzschutz.de

 .de/en

 .de/fr

 .de/nl



[instagram.com/abssafety](https://www.instagram.com/abssafety)



[youtube.com/abssafetygmbh](https://www.youtube.com/abssafetygmbh)



[facebook.com/ABS.Safety](https://www.facebook.com/ABS.Safety)



[linkedin.com/company/abs-safety-gmbh](https://www.linkedin.com/company/abs-safety-gmbh)



[xing.com/pages/abssafetygmbh](https://www.xing.com/pages/abssafetygmbh)