

# ABS-Lock<sup>®</sup> X-Rivet

LX-SW-N-XXX

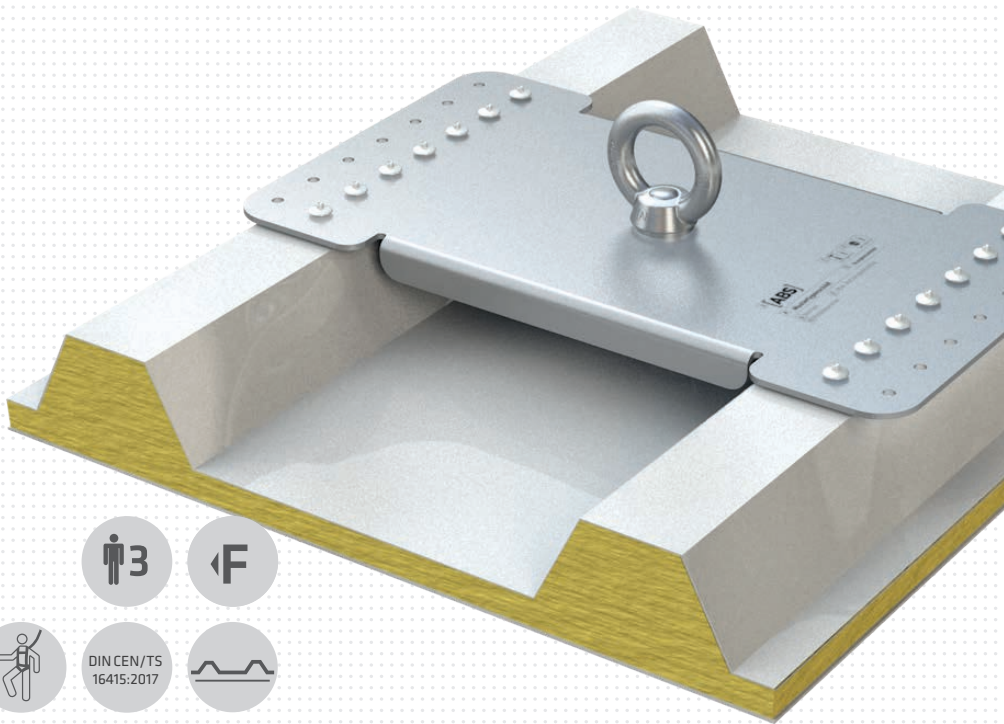

MoA 092-13



## Werkzeuge | Tools

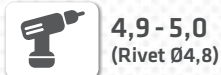

## Sicherheitshinweise | Safety instructions



- DE** Montageanleitung beachten (1) und Sicherheitshinweise beachten (2).
- EN** Comply with the installation manual (1) and Comply with the safety instructions (2).
- FR** Respecter la notice de montage (1) and Respecter les consignes de sécurité (2).
- NL** Montagehandleiding in acht nemen (1) and Veiligheidsinstructies in acht nemen (2).
- BGR** Спазвайте инструкциите за монтаж (1) and Спазвайте инструкциите за безопасност (2).
- DK** Følg monteringsvejledningen (1) and Følg sikkerhedshenvisningerne (2).
- ET** Järgige paigaldusjuhendit (1) ja ohutusjuhiseid (2).
- FI** Noudata asennusohjeita (1) and Noudata turvallisuusohjeita (2).
- IT** Rispettare le istruzioni di montaggio (1) and Rispettare le istruzioni di sicurezza (2).
- PL** Przestrzegać zaleceń instrukcji montażu (1) and Przestrzegać zasad bezpieczeństwa (2).
- SK** Dodržujte návod na montáž (1) and Dodržujte bezpečnostné pokyny (2).
- SL** Sledite navodilom za namestitve (1) and Sledite varnostnim navodilom (2).
- ES** Observar las instrucciones de montaje (1) and Observar las indicaciones de seguridad (2).
- CS** Dodržujte návod k montáži (1) and Dodržujte bezpečnostní pokyny (2).
- HU** Vegye figyelembe az összeszerelési útmutatót (1) and Vegye figyelembe a biztonsági utasításokat (2).

Für eine ordnungsgemäße Montage ist eine Dokumentation des Einbaus zwingend erforderlich!  
For a proper installation, a complete documentation of assembly is absolutely necessary.

## Kontakte | Contact persons

**Vertrieb & Technische Beratung**  
Sales & Technical Support

+49 (0) 28 32 - 972 81 - 0  
vertrieb@absturzschutz.de

**Schulung**  
Training

+49 (0) 28 32 - 972 81 - 148  
schulung@absturzschutz.de

**Montagevorbereitung**  
Assembly

+49 (0) 28 32 - 972 81 - 260  
service@absturzschutz.de

## Mustertypenschild | Sample label

[ABS]

**ABS SAFETY GMBH** 3

Kevelaer, Germany  
info@absturzschutz.de  
www.absturzschutz.de

1

2

---

**Mustertypenschild / Sample only** 4

<b>6</b>	Normen / Standards	<input type="checkbox"/>	-
<b>7</b>	Max. Nutzer gleichzeitig (DIN EN 795:2012) Max. No. of simultaneous users	<input type="checkbox"/>	-
<b>11</b>	Modellnummer / Model number	<input type="checkbox"/>	-
<input type="checkbox"/>	-	<input type="checkbox"/>	-
<input type="checkbox"/>	-	<input type="checkbox"/>	-
<input type="checkbox"/>	-	<input type="checkbox"/>	-

**Chargennummer / Batch number** 5

---

CE

0158

U

Z-14.9-688

9

DEKRA

10

DEKRA

# Montageschritte dokumentieren

Document assembly step



Dokumentation mit Bildern vervollständigen!  
Complete your documentation using pictures!

**Dokumentation  
ist Pflicht!**

Documentation is compulsory!

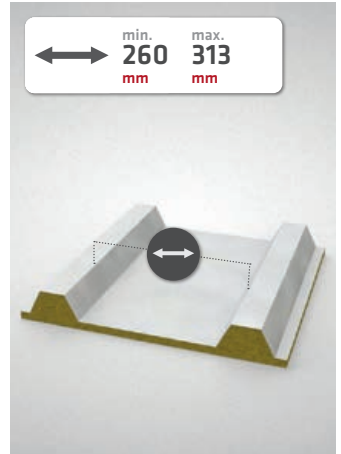
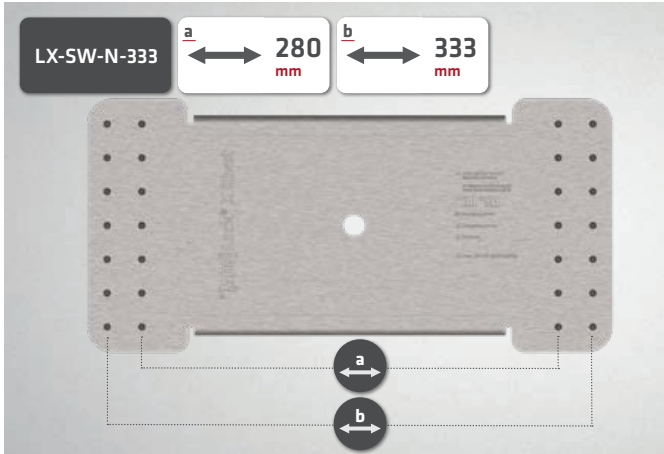
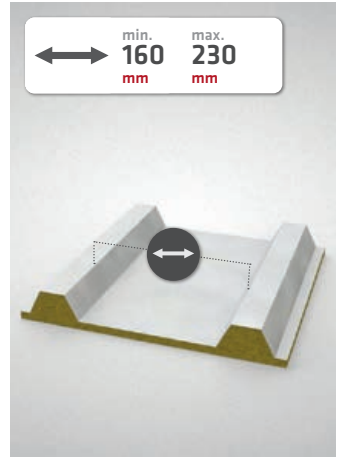
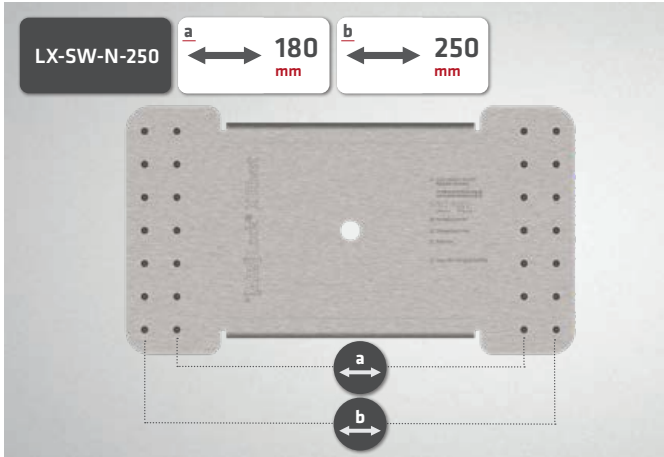

↓  
Ø4,8  
mm

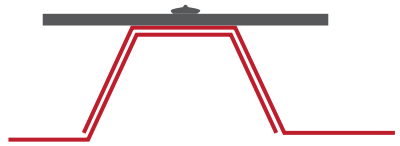
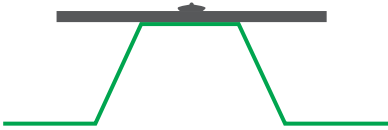
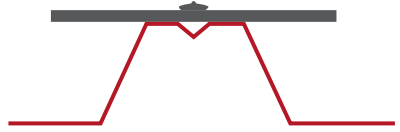
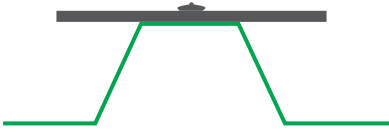



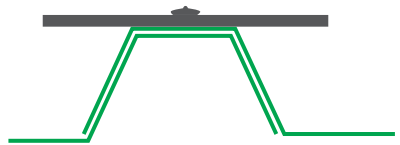
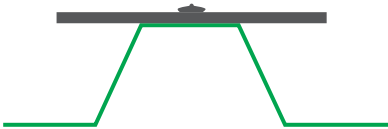
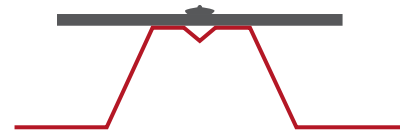
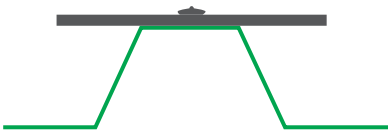

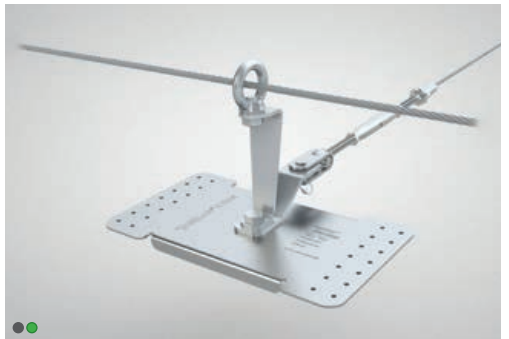
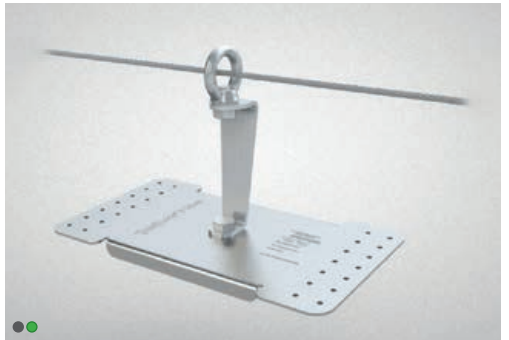
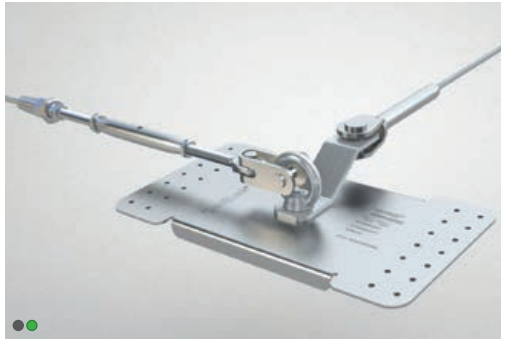
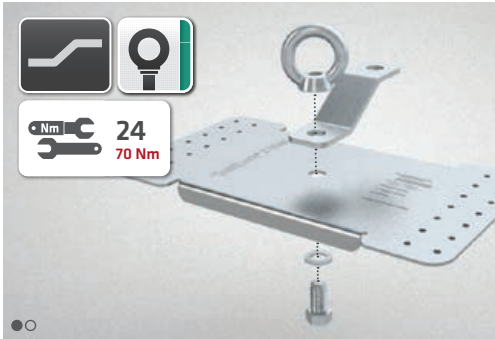
↓  
Ø6,4  
mm

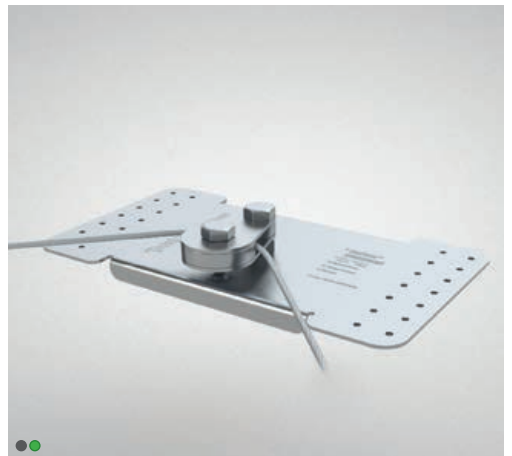
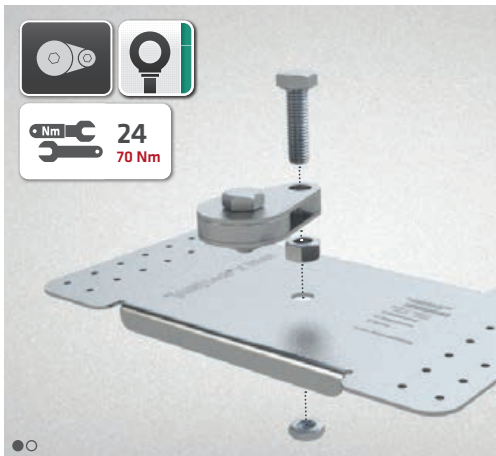
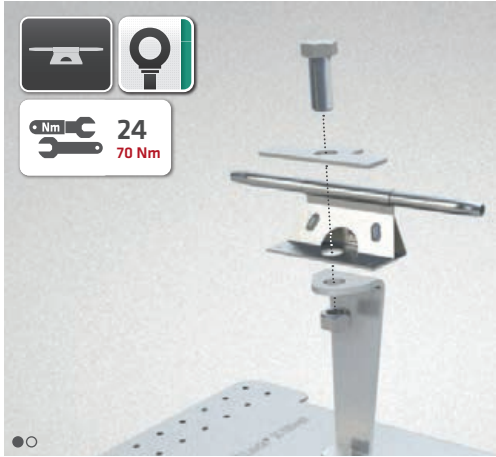
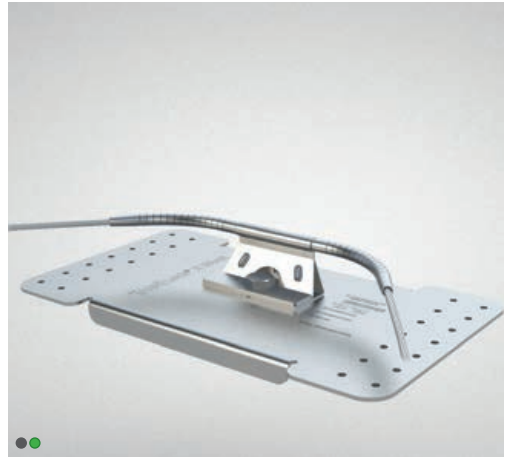











**4,9 - 5,0**
 min. **10 mm**
 min. **500 mm**

<b>Steel</b>	min. <b>0,45 mm</b>	max. <b>1 mm</b>
<b>Alu</b>	min. <b>0,8 mm</b>	max. <b>1 mm</b>

  
**Ø4,8 mm**



●○○○○



**6,5 - 6,7**
 min. **10 mm**
 min. **500 mm**

<b>Steel</b>	min. <b>0,45 mm</b>	max. <b>2 mm</b>
<b>Alu</b>	min. <b>0,8 mm</b>	max. <b>2 mm</b>

  
**Optional**
  
**Ø6,4 mm**

●○○○○

●○○○○

**X**

**press**

**✓**





4,9 - 5,0

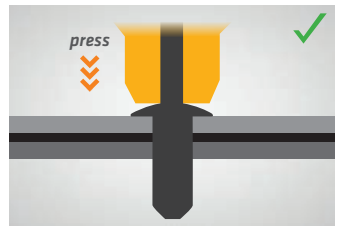
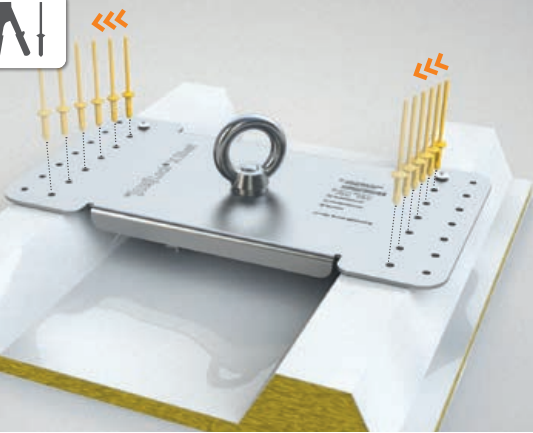
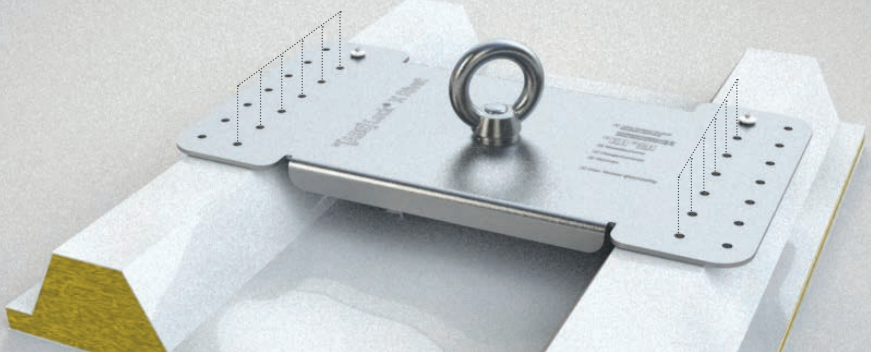

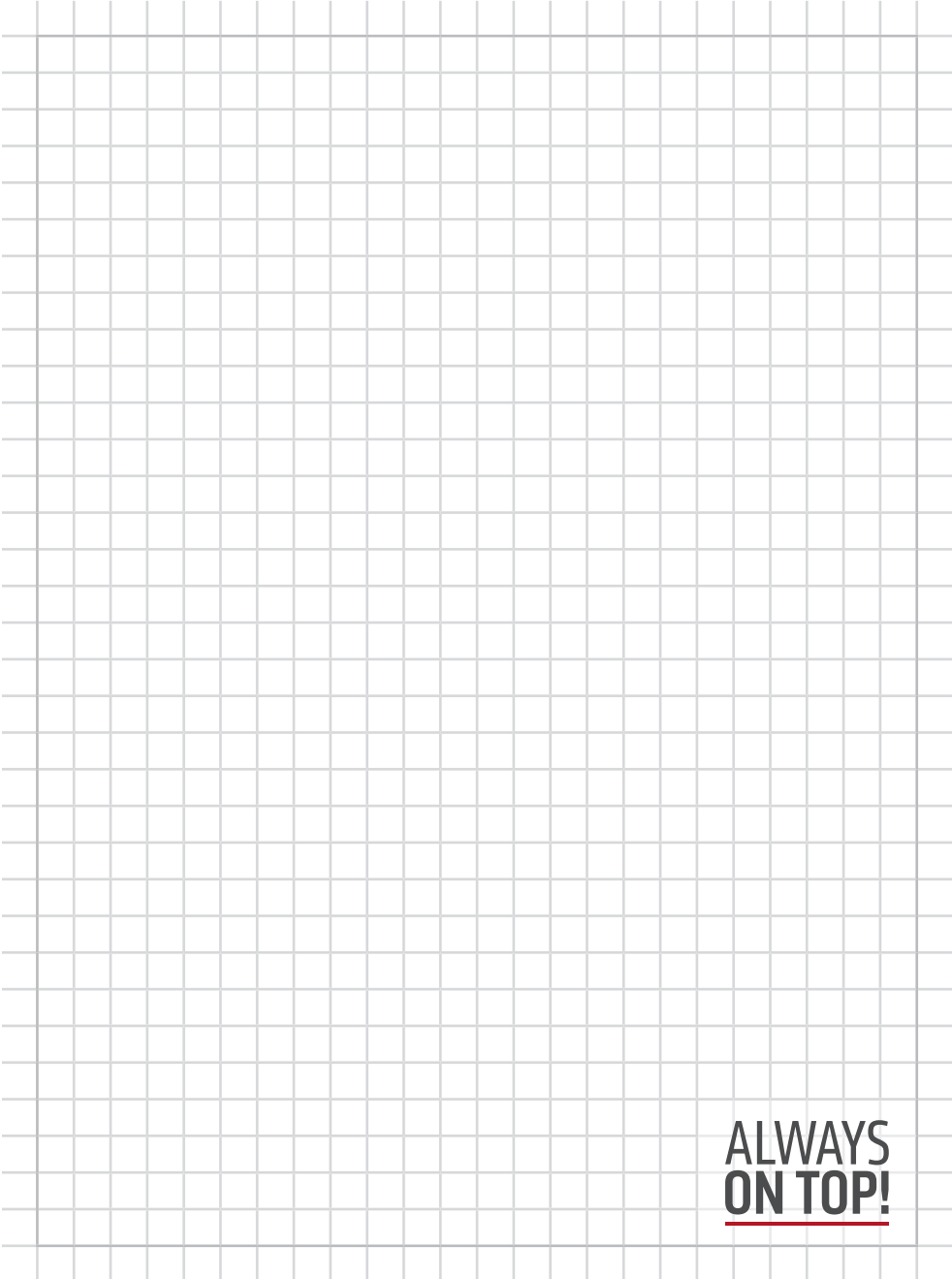

**ALWAYS  
ON TOP!**



# ALWAYS ON TOP!

## ABS Safety GmbH

Gewerbering 3  
D-47623 Kevelaer  
Germany

Tel.: +49 28 32 972 81 - 0  
Fax: +49 28 32 972 81 - 285

[info@absturzsicung.de](mailto:info@absturzsicung.de)

 [www.absturzsicung.de](http://www.absturzsicung.de)

 [.de/en](http://.de/en)

 [.de/fr](http://.de/fr)

 [.de/nl](http://.de/nl)

EL 6. März 2023



[instagram.com/abssafety](https://www.instagram.com/abssafety)



[youtube.com/abssafetygmbh](https://www.youtube.com/abssafetygmbh)



[facebook.com/ABS.Safety](https://www.facebook.com/ABS.Safety)